



¡NOVEDAD!



***¡MAYOR POTENCIA,
MAYOR RENDIMIENTO!***



bahco.com

TIJERAS DE PODAR INALÁMBRICAS DE ÚLTIMA GENERACIÓN

Nuestra nueva generación de tijeras de podar sin cable te lleva al siguiente nivel de experiencias de poda, ya sea cuando se trabaja en viñedos, huertos o jardines ornamentales.

Incorpora motores sin escobillas de último diseño con electrónica avanzada para una potencia infinita y una velocidad de corte excepcional. La hoja de acero SK5 de alta calidad viene con un recubrimiento de polímero para una mayor durabilidad y protección contra el óxido.



POTENCIA

Potencia de corte infinita gracias al motor sin escobillas con electrónica avanzada.



VELOCIDAD

Mayor velocidad de corte para maximizar la eficiencia y aumentar su productividad.



HOJA

Nueva y resistente hoja de acero SK5 forjada de una sola pieza para una mayor durabilidad y un menor mantenimiento. El revestimiento de polímero proporciona una mayor resistencia a la corrosión y baja fricción para una mayor autonomía de la batería.



AJUSTE DE LAS HOJAS

Aumenta la vida útil de las hojas utilizando el nuevo sistema de control de cruce.



SENSIBILIDAD AUMENTADA DEL GATILLO

Corte progresivo, control extremo del corte. Elige fácilmente la capacidad de corte deseada:

- **Opción 1:** Cierra las hojas durante un segundo para elegir entre las dos aperturas de hoja preajustadas.
- **Opción 2:** Utiliza el gatillo progresivo para seleccionar cualquier capacidad de corte deseada para maximizar la eficacia. Mantén pulsado durante un segundo la apertura de hoja deseada.



BCL226



BCL235



BCL240

BCL226

PODA LIGERA HASTA 26 MM

Nuestras tijeras de podar super compactas **BCL226** son ideales para poda rápida y suave de pequeñas vides y ramas finas.

Hoja de acero SK5 de alta calidad. Recubrimiento de polímero extra resistente al desgaste y a la corrosión.

RECAMBIOS Y CONSUMIBLES

Hoja	BCL22604
Contrahoja	BCL22605
Grasa de litio	BCL2LGRE
Grasa	BCL2GR
Cargador	BCL226C
Batería	BCL226B
Afilador	SHARP-X LS-CORINDON



Ø 26 mm
Ø 15 mm



920 g
Batería incluida

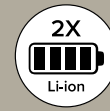

2X
Li-ion
10.8 V - 2.5 Ah
Salida 27 Wh
Incluye 2 baterías



Tiempo de carga
90 min
Doble conexión

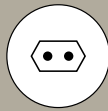

Enchufe europeo
(tipo C)

ACCESORIOS (opcionales)



Funda para batería
(para BCL226B & BCL1B031B)
BCL20BP



Funda
(para BCL226 & BCL235)
BCL2HOL



BCL235

MAXIMIZAR TU LIBERTAD DE MOVIMIENTOS

Nuestras tijeras de podar compactas **BCL235IB** son ideales para la poda ligera de enredaderas, así como de arbustos y pequeños árboles ornamentales.

Hoja de acero SK5 forjado de una sola pieza de alta calidad. Recubrimiento de polímero extra resistente al desgaste y a la corrosión.

RECAMBIOS Y CONSUMIBLES

Hoja	BCL23504
Contrahoja	BCL23505
Grasa de litio	BCL2LGRE
Grasa	BCL2GR
Cargador	BCL1C41B
Batería	BCL1B031B
Afilador	SHARP-X LS-CORINDON



Ø 35 mm
Ø 18 mm



970 g
Batería incluida

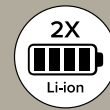

2X
Li-ion
14.4 V - 2.5 Ah
Salida 36 Wh
Incluye 2 baterías



Tiempo de carga
90 min
Doble conexión

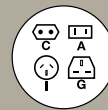

4 adaptadores
de corriente

BCL240

MANTENER LA VANGUARDIA EN HUERTOS Y JARDINES

Con nuestra **BCL240** podarás cómodamente frutales de pepita y árboles ornamentales grandes o maduros. Hoja de acero SK5 forjado de una sola pieza de alta calidad. Recubrimiento de polímero extra resistente al desgaste y a la corrosión.



RECAMBIOS Y CONSUMIBLES

Hoja	BCL24004
Contrahoja	BCL24005
Grasa de litio	BCL2LGRE
Grasa	BCL2GR
Cargador	BCL1C5IB
Batería	BCL1B06IB
Afilador	SHARP-X LS-CORINDON

ACCESORIOS (opcionales)



Funda
(para BCL240)
BCL2HOL



Funda para batería
(para BCL240)
BCL25BP



Ø 40 mm
Ø 27 mm



1,230 g
Batería incluida



21.6 V - 2.5 Ah
Salida 54 Wh
Incluye 3 baterías



Tiempo de carga
150 min
Triple conexión

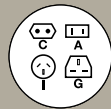

4 adaptadores
de corriente

BCL25TP

LLEGAR MÁS ALTO SIN COMPROMETER LA SEGURIDAD

Las tijeras de podar **BCL240** pueden acoplarse fácilmente a nuestra pértiga telescópica **BCL25TP** cuando se necesita un mayor alcance. Con esta robusta pértiga de aluminio podrás podar con seguridad y facilidad hasta **4,3 metros de altura**.

PÉRTIGA TELESCÓPICA BCL25TP (OPCIONAL)

Peso	1,350 g
------	---------



2.2 M

Pértiga telescópica
BCL25TP

1.5 M

MAX. 4.3 M

BCL23

TRABAJAR TODO EL DÍA CON GRAN FACILIDAD Y ALTA PRECISIÓN

Nuestras potentes tijeras de podar **BCL23** son la referencia para la poda intensiva de la viña, permitiendo podar eficazmente con un alto nivel de comodidad, precisión y con una potencia de corte excepcional, convirtiendo la poda pesada en un trabajo ligero. Corta sin esfuerzo desde ramas pequeñas a gruesas y desde madera blanda a muy dura.



RECAMBIOS Y CONSUMIBLES

Hoja	BCL2304
Contrahoja	BCL2305
Grasa de litio	BCL2LGRE
Grasa	BCL2GR
Cargador	BCL2C1
Batería	BCL2B1
Afilador	SHARP-X LS-CORINDON

INCLUIDOS



Cinturón
(BCL23)
BCL2BE

Funda
(BCL23 & BCL24)
BCL2HOL

Brazalete
(BCL23 & BCL24)
BCL2AB

Arnés
(BCL24)
BCL20H

BCL24

CORTA RAMAS GRUESAS Y MADERA DURA CON FACILIDAD

Nuestras potentes tijeras de podar **BCL24** son la referencia cuando se trata de cortar y podar madera muy gruesa y dura. Proporcionan una excelente potencia, un acabado muy limpio del corte y permiten realizar cortes precisos incluso en madera excepcionalmente dura. Convierten la poda pesada en un trabajo ligero, especialmente en la poda de frutales de hueso, olivos, cítricos y nogales.

RECAMBIOS Y CONSUMIBLES

Hoja	BCL2404
Contrahoja	BCL2405
Grasa de litio	BCL2LGRE
Grasa	BCL2GR
Cargador	BCL2C1
Batería	BCL2B2
Afilador	SHARP-X LS-CORINDON



BCL23



Ø 35 mm
Ø 23 mm



880 g



43.2 V - 3.4 Ah
Salida 147 Wh
Autonomía 8-10 h
1.050 g



Tiempo de carga
90 min



USB
Power bank



BCL24



Ø 45 mm
Ø 30 mm



1,020 g



43.2 V - 6.8 Ah
Salida 294 Wh
Autonomía 8-10 h
1,900 g



Tiempo de carga
200 min



USB
Power bank

BCL104 ¡NOVEDAD!

**CORTA CON FACILIDAD
RAMAS DE HASTA 90 MM
DE GROSOR**

Nuestra motosierra ultracompacta **BCL104** es especialmente adecuada para ramas pequeñas, poda y leña. Combina potencia, portabilidad y facilidad de uso.

CAPACIDAD DE CORTE: 90 MM
VELOCIDAD DE CORTE: 6 M/S

RECAMBIOS Y CONSUMIBLES

Barra de cadena 4"	BCL10402
Cadena de 29 dientes 1/4"	BCL10403
Batería	BCL226B
Cargador	BCL226C



300W



90 mm
Velocidad
6 m/s



1.0 kg



29 dientes 1/4"



10.8 V - 2.5 Ah
27 Wh
Incluye 2 baterías

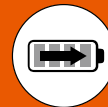

Tiempo de carga
90 min

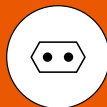

Enchufe europeo
(tipo C)

ACCESORIO (opcional)



Funda
(para BCL151B + BCL104)
BCL15HOL



BCL151B

**CORTA RAMAS GRUESAS
SIN ESFUERZO**

Compacta pero potente, nuestra motosierra **BCL151B** ofrece una capacidad de corte excepcional y permite cortar sin esfuerzo ramas muy gruesas e incluso árboles pequeños de hasta 110 mm de diámetro, ya sea en huertos, viñedos o espacios verdes. Gracias a su diseño ligero, la **BCL151B** también permite cortar cómodamente por encima de la cabeza.

CAPACIDAD DE CORTE: 110 MM
VELOCIDAD DE CORTE: 11 M/S

RECAMBIOS Y CONSUMIBLES

Barra de cadena	BCL1502
Cadena de 38 dientes 1/4"	BCL1503
Batería	BCL1B081B
Cargador	BCL1C51B



600W



110 mm
Velocidad
11 m/s



1,800 g



38 dientes 1/4"



21.6 V - 4 Ah
86.04 Wh
Incluye 3 baterías



Tiempo de carga
270 min
Conexión triple

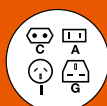

4 adaptadores
de corriente



2.60 M
PÉRTIGA
TELESCÓPICA
1.95 M

¡NOVEDAD!

BCL108PS

**CORTA Y RECORTA DE FORMA
SEGURA Y CÓMODA SIN ESCALERA,
ALCANZANDO HASTA 4,6 METROS**

Nuestra sierra de pértiga ultraversátil **BCL108PS** permite podar ramas altas de forma segura desde el suelo. Ofrece un rendimiento de corte suave en ramas de hasta 200 mm de grosor. La pértiga telescópica, su diseño ligero y su mango suave al tacto proporcionan un control y una comodidad excepcionales. Ideal para la poda de olivos y árboles frutales, el mantenimiento de jardines y la formación de árboles, todo ello sin necesidad de escaleras ni cables.

**CAPACIDAD DE CORTE: 200 MM
VELOCIDAD DE CORTE: 12 M/S**

RECAMBIOS Y CONSUMIBLES

Barra de cadena 8"	BCL108PS02
Cadena de 48 dientes 1/4"	BCL108PS03
Batería	BCL1B10IB
Cargador	BCL1C5IB

950W



200 mm
Velocidad
12 m/s



3.0 kg



48 dientes 1/4"

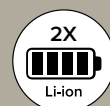

21,6 V - 5 Ah
108 Wh
Incluye 2 baterías



Tiempo de carga
240 min

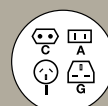

4 adaptadores
de corriente

GRANDES COMBINACIONES DE MOTOSIERRA CON TIJERAS DE PODAR



IDEAL PARA UNA PODA SUAVE



Tijeras de podar BCL226 + Motosierra BCL104

Nuestra motosierra ultracompacta BCL104 y nuestras tijeras de podar compactas BCL226 son un conjunto de herramientas versátiles y eficientes para la poda suave, la jardinería y el cuidado ligero de los árboles. Ambas utilizan la misma batería.



IDEAL PARA LA PODA DE ÁRBOLES FRUTALES



Tijeras de podar BCL240 + Motosierra BCL151B

La motosierra BCL151B, combinada con nuestras tijeras de podar BCL240, es una pareja ideal para podar y cortar árboles frutales. Las baterías de las tijeras de podar BCL240 y la motosierra BCL151B son fácilmente intercambiables.



IDEAL PARA LA PODA DE OLIVOS



Tijeras de podar BCL24 + Motosierra BCL151B

La motosierra BCL151B y nuestras tijeras de podar BCL24 son la combinación ideal para la poda intensiva de olivos. La motosierra puede alimentarse con las baterías de las tijeras de podar mediante un cable de conexión.

SOLUCIONES DE ALIMENTACIÓN

PARA QUE TODO VAYA SOBRE RUEDAS

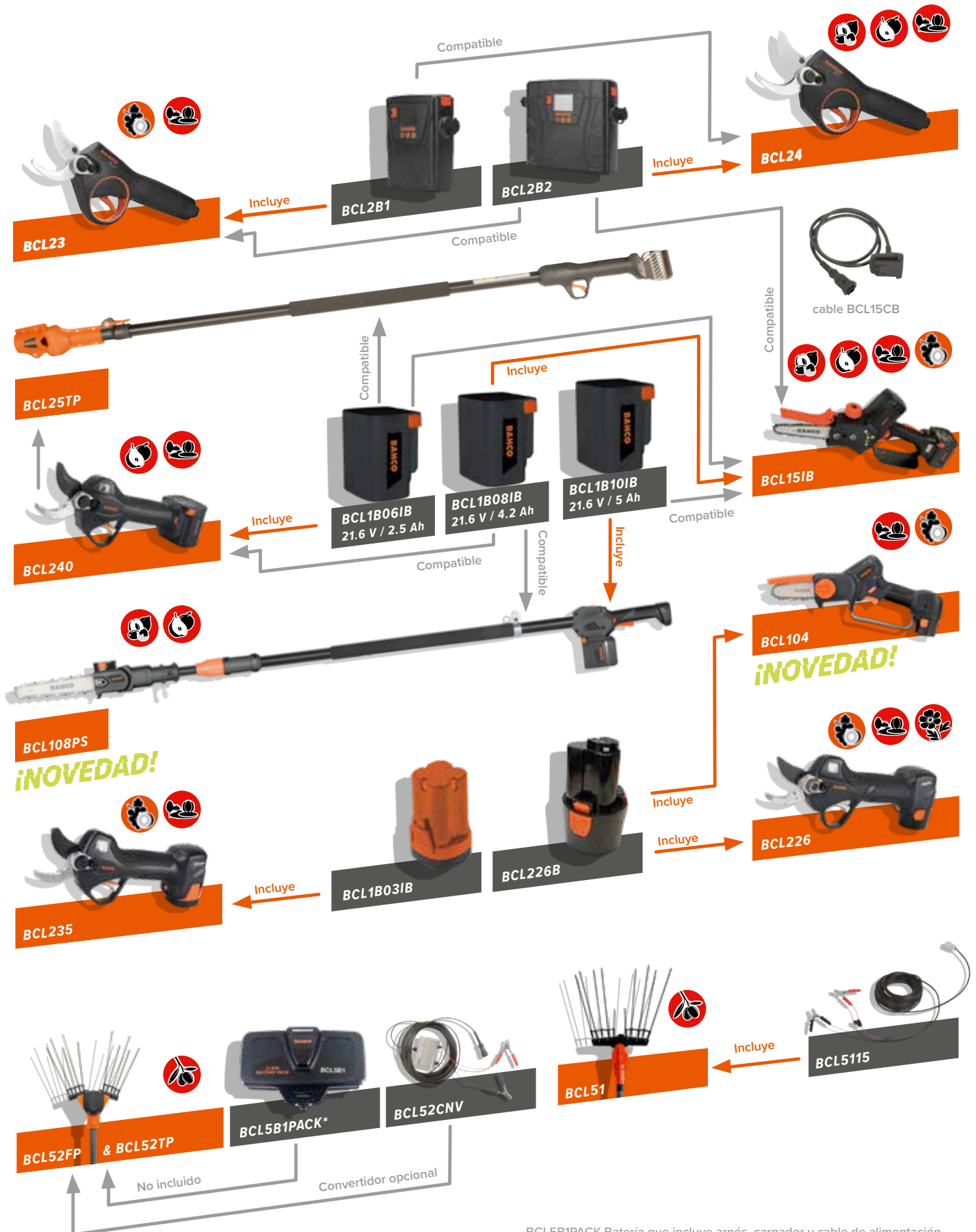

BCL5B1PACK Bateria que incluye arnés, cargador y cable de alimentación
 BCL5B1 Bateria, sin arnés, cargador ni cable de alimentación

BCL52TP / BCL52FP

MAXIMIZAR LA EFICIENCIA EN LA COSECHA DE ACEITUNAS

Nuestros vareadores de aceitunas **BCL52FP** y **BCL52TP**, ligeros y fáciles de maniobrar, con potentes motores sin escobillas, garantizan un funcionamiento sin problemas durante la recolección de aceitunas.

La combinación adecuada de selección de materiales, peso, equilibrado y vibración no sólo minimiza el impacto sobre las aceitunas y las ramas, sino que también tiene un efecto positivo sobre la salud de los usuarios, que suelen estar expuestos a diversos riesgos musculoesqueléticos causados por las altas vibraciones de las sacudidoras.



Alcance de trabajo 600 mm

2 x 5 varillas flexibles
de fibra de carbono de 330 mm



BCL52TP & BCL52FP



5 + 5 carbono
330 mm
BCL5201



5 velocidades
de 950 BPM
a 1,200 BPM



600 mm

ACCESORIOS Y PIEZAS DE RECAMBIO BCL52TP & BCL52FP

Pack de baterías (arnés, cargador, cable)	BCL5B1PACK
Batería (solo)	BCL5B1
Convertidor de 12 V	BCL52CNV
Aarnés	BCL5H
Cargador	BCL5C1

ELIGE LA OPCIÓN DE ALIMENTACIÓN QUE SE ADAPTE A TUS NECESIDADES

Nuestros vareadores de aceitunas **BCL52FP** y **BCL52TP** pueden funcionar con nuestra batería de 36 V BCL5B1 o, con nuestro convertidor de 36 V a 12 V BCL52CNV, con un sistema de batería de coche de 12 V. El sistema de batería de coche de 12 V puede cargarse fácilmente con el cargador automático BBCE12-6.



TELESCÓPICO
2.16 M > 2.96 M

BCL52TP

2,250 g
Potencia máxima 700W
Alimentación del motor 36 V
(Max. 43 V)

BCL52FP

1,900 g (sin extensión)
Potencia máxima 700W
Alimentación del motor 36 V
(Max. 43 V)



BCL51

BENEFÍCIATE DE UNA GRAN SELECCIÓN DE PRÁCTICAS FUNCIONES

Nuestro vareador de aceitunas **BCL51** ofrece todas las funciones esenciales y es una excelente elección para realizar fácilmente todas las tareas más comunes en la recolección de aceitunas. Con su robusta pértiga de aluminio de 2.300 mm y su extensión adicional de 1.000 mm, permite trabajar cómodamente a mayor altura. El vareador de aceitunas **BCL51** se suministra con un cable de alimentación de 14 m para funcionar con un sistema de batería de coche de 12 V.

- Pértiga fija de aluminio de 2.300 mm
- Incluye una extensión de aluminio de 1.000 mm
- Dos peines con movimiento opuesto - 400 mm



5 + 5 carbono
2 x 120 mm
8 x 275 mm
BCL5101



1,650 BPM



400 mm

FUENTE DE ALIMENTACIÓN



BCL52CNV
Convertidor de 36 V a 12 V
BCL52TP & BCL52FP
(opcional)



BCL5B1PACK
720 Wh (20 Ah) para una
autonomía de 5 a 6 horas |
3,700 g
BCL52TP & BCL52FP
(opcional)



BBCE12-6
Cargador de 6A para
baterías de 12V | 1,190 g
BCL52TP & BCL52FP
(opcional)



CABLE DE ALIMENTACIÓN
para 12V - 14 metros
BCL5115
(incluido)

BCL51
2,200 g (sin extensión)
Potencia máxima 370W
Alimentación del motor 12 V

CUIDAMOS DE TUS HERRAMIENTAS

ASISTENCIA ESPECIALIZADA, SERVICIO PROFESIONAL Y REPARACIONES



Contamos con una red de más de 100 centros de servicio y reparación en 15 países y, además, con un servicio de asistencia interno con tres centros de servicio y reparación en Francia, los Países Bajos y España. Allí, tus herramientas serán mantenidas y reparadas por expertos cualificados y con piezas de repuesto originales. Para sacar el máximo partido a sus herramientas y mantenerlas en buen estado temporada tras temporada, queremos ayudarte a cuidarlas y protegerlas. Un mantenimiento y cuidado adecuados de tus herramientas prolongarán significativamente su vida útil y reducirán el coste total.



En BCL23 y BCL24 a partir de la fecha de entrega, siempre que el mantenimiento anual se realice en un centro de servicio certificado después del primer año. Los consumibles como las hojas, sujetos a desgaste por uso, quedan excluidos de la garantía.



En BCL226, BCL235, BCL240, BCL25TP, BCL104, BCL108PS, BCL152FP, BCL152TP, BCL151B, BCL151 y todas las baterías. Los consumibles como las hojas, sujetos a 'desgaste por uso', quedan excluidos de la garantía.

¡REGISTRA TU HERRAMIENTA!

Cada una de nuestras tijeras eléctricas, motosierras y vareadores de aceitunas Bahco tiene un número de serie único.

Al registrar tu herramienta con nosotros, nos ayudas a realizar un seguimiento del producto. Si hay algún aviso o retirada del producto, podremos ponernos en contacto contigo fácilmente para darte instrucciones sobre cómo proceder. Además, serás el primero en recibir información sobre las últimas actualizaciones, nuevos accesorios o novedades del servicio posventa.



BAHCO®



CATÁLOGO PODA Y RECOLECCIÓN | 2025



Poda y recolección 2025

Catálogo

Tijeras de podar de una mano	30
Herramienta de recogida de fruta	33
Tijeras de podar de 2 manos	34
Serruchos con pértiga y podaderas de altura	36
Cortasetos	38
Cortacéspedes	40
Navajas de poda	40
Tijeras	40
Arcos tronzadores	41
Serruchos de poda	42
Repuestos y accesorios	44
Accesorios y mantenimiento	44
Hachas y mazas	45
Cuñas	47
Pequeñas herramientas de jardinería	47
Podadera neumática	48
Tijeras de poda eléctricas, motosierras y accesorios	49
Vareadores y accesorios	54

Precios válidos a partir de 1 de abril de 2025



ICONOGRAFÍA



Heavy Duty



Ligero



Recambios disponibles



Corte fino



Corte medio



Corte grueso



Para zurdos



Para diestros



Uso ocasional



Uso frecuente



Uso intensivo

Panel de confort

CORTE DESLIZANTE (para todas las hojas de corte bypass)

LA CLAVE PARA UN ALTO RENDIMIENTO

LA CLAVE PARA UN ALTO RENDIMIENTO

- Menor esfuerzo durante el corte.
- Menor desgaste y más vida útil de la hoja.
- Menor rotura de hojas.



CÓMO FUNCIONA

La afilada hoja curva favorece que el filo se "deslice" mientras va penetrando en la rama para realizar el corte. El perno central descentrado produce un mayor efecto deslizando aumentando la superficie de la hoja utilizada durante el corte.

POR QUÉ FUNCIONA

Imagine el corte de una rebanada de pan. No importa lo afilado que esté el cuchillo, si sólo se presiona hacia abajo sin deslizarlo, el molde de pan se aplastará y le costará realizar el corte, necesitará más fuerza y el molde quedará deformado. El molde de pan y una rama se comportan de manera similar, ambos podrán ser cortados de una manera mucho más eficaz si realizamos un corte deslizando junto con una presión descendente.

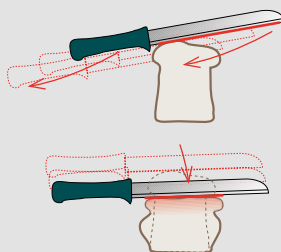

EL FILO DE LA HOJA

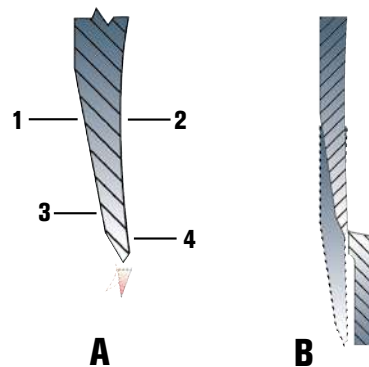

EL FILO SE OBTIENE CON CUATRO OPERACIONES DE AFILADO (DIBUJO A):

- 1- Biselado principal, se afila el área de corte de la hoja.
- 2- Cavidad, se afila una pequeña cavidad en la cara interior de la hoja.
- 3- Segundo bisel, se pule el borde hasta obtener el filo de una hoja de afeitar.
- 4- Biselado trasero, se afila un ángulo rectificado en la cara interior.

MENOR FRICCIÓN Y ATORAMIENTO (DIBUJO B)

Gracias a la concavidad en la cara interior de la hoja, la hoja está en contacto con la contrahoja en el punto de corte. La reducción en la fricción y en el pegado de las hojas facilita el deslizamiento e incrementa el rendimiento de la herramienta.

TECNOLOGÍA DE LA HOJA

Hay dos cabezales de corte: BYPASS y el yunque, y a pesar de que los dos pueden cortar la mayoría de tipos de madera, cada tipo tiene unas características de diseño que hacen que sea especialmente bueno para su uso particular

PODADERAS DE CORTE DESLIZANTE (BYPASS): PARA CORTAR MADERA VERDE

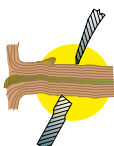

Mientras la hoja corta, la contrahoja también presiona la madera.

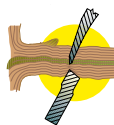

La rama que eliminamos puede ser dañada

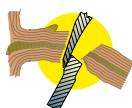

Pero el corte en sí es limpio y liso.

CIZALLA: PARA MADERA ADULTA Y SECA

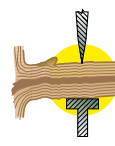

La hoja estrecha penetra en la madera

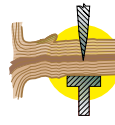

El ancho yunque distribuye las cargas y sujeta la rama.



Hasta que el corte es completo.

PODADERAS

PODADERAS ERGONÓMICAS



¿QUÉ HACE QUE LAS PX Y PXR SEAN ERGONÓMICAS?

CARACTERÍSTICAS

- Inclinación vertical y lateral.
- Forma de los mangos.
- Recubrimiento de elastómero del mango superior.
- Elección de la cabeza de corte.
- Elección del muelle.
- Sistema de medición de la mano.

BENEFICIOS

- Mantiene la muñeca en una posición neutral.
- Comodidad en su uso.
- Ayuda a repartir la presión equitativamente.
- Elección de la cabeza de corte según sea el trabajo a realizar.
- La podadera se adapta a la fuerza de la mano.
- Le ayuda a encontrar la mejor podadera para usted.



INCLINACIÓN VERTICAL











Comparada con una podadera tradicional, la inclinación hacia abajo de la PX y PXR compensa la posición de la muñeca, permitiendo que ésta permanezca en una posición más neutral. Esta postura reduce el riesgo de padecer el síndrome del túnel carpiano.



INCLINACIÓN LATERAL

Comparada con una podadera tradicional, las PX y PXR presentan una inclinación lateral hacia el interior compensando de esta manera la postura de la muñeca, permitiendo que la mano permanezca en una posición más natural. Esta posición reduce el riesgo de sufrir enfermedades músculo - esqueléticas.

El sistema modular de las podaderas ergonómicas PX y PXR no sólo le permite elegir el mango que se adapta al tamaño de su mano, sino también al elegir el tamaño de la cabeza de corte se obtiene la capacidad de corte adecuada adaptada a la tarea a realizar.

PX		nº1  Capacidad de corte 15mm 1/2"	nº2  Capacidad de corte 20mm 3/4"	nº3  Capacidad de corte 30mm 1 1/4"
PX-S	Mango fijo, pequeña	PX-S1	PX-S2	
PX-M	Mango fijo, mediana	PX-M1	PX-M2	PX-M3
PX-M-L	Mango fijo, mediana - para zurdos		PX-M2-L 	
PX-L	Mango fijo, grande		PX-L2	PX-L3
PXR		nº1  Capacidad de corte 15mm 1/2"	nº2  Capacidad de corte 20mm 3/4"	nº3  Capacidad de corte 30mm 1 1/4"
PXR-S	Mango giratorio, pequeña	PXR-S1	PXR-S2	
PXR-M	Mango giratorio, mediana	PXR-M1	PXR-M2	PXR-M3
PXR-M-L	Mango giratorio, mediana, para zurdos		PXR-M2-L 	
PXR-L	Mango giratorio, grande		PXR-L2	



Guía para medición de manos para las podaderas Ergo™ PX y PXR

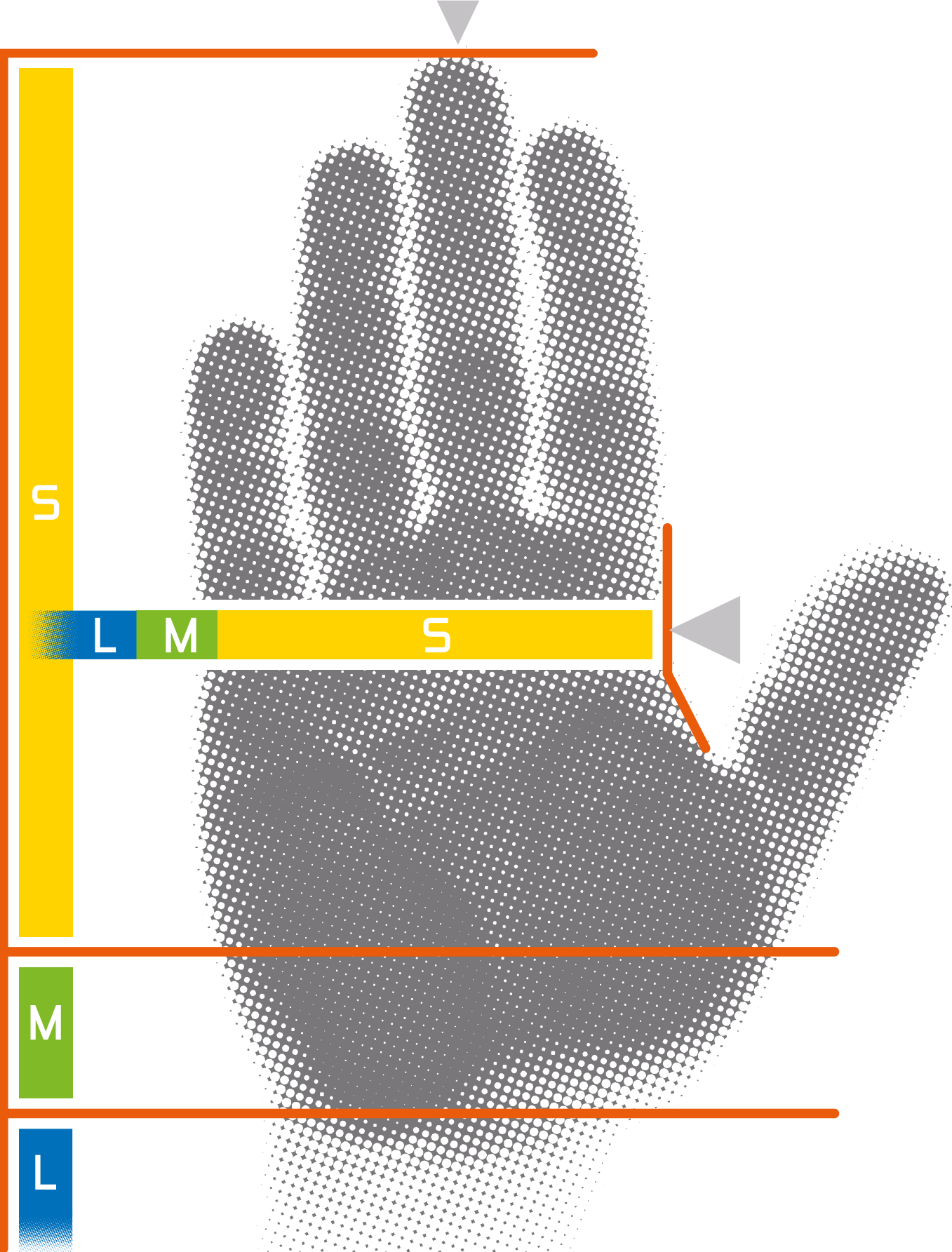

1

Mida la mano desde la base del dedo índice para determinar el ancho de la mano



2

Mida desde la punta del dedo a la muñeca para determinar la longitud de la mano

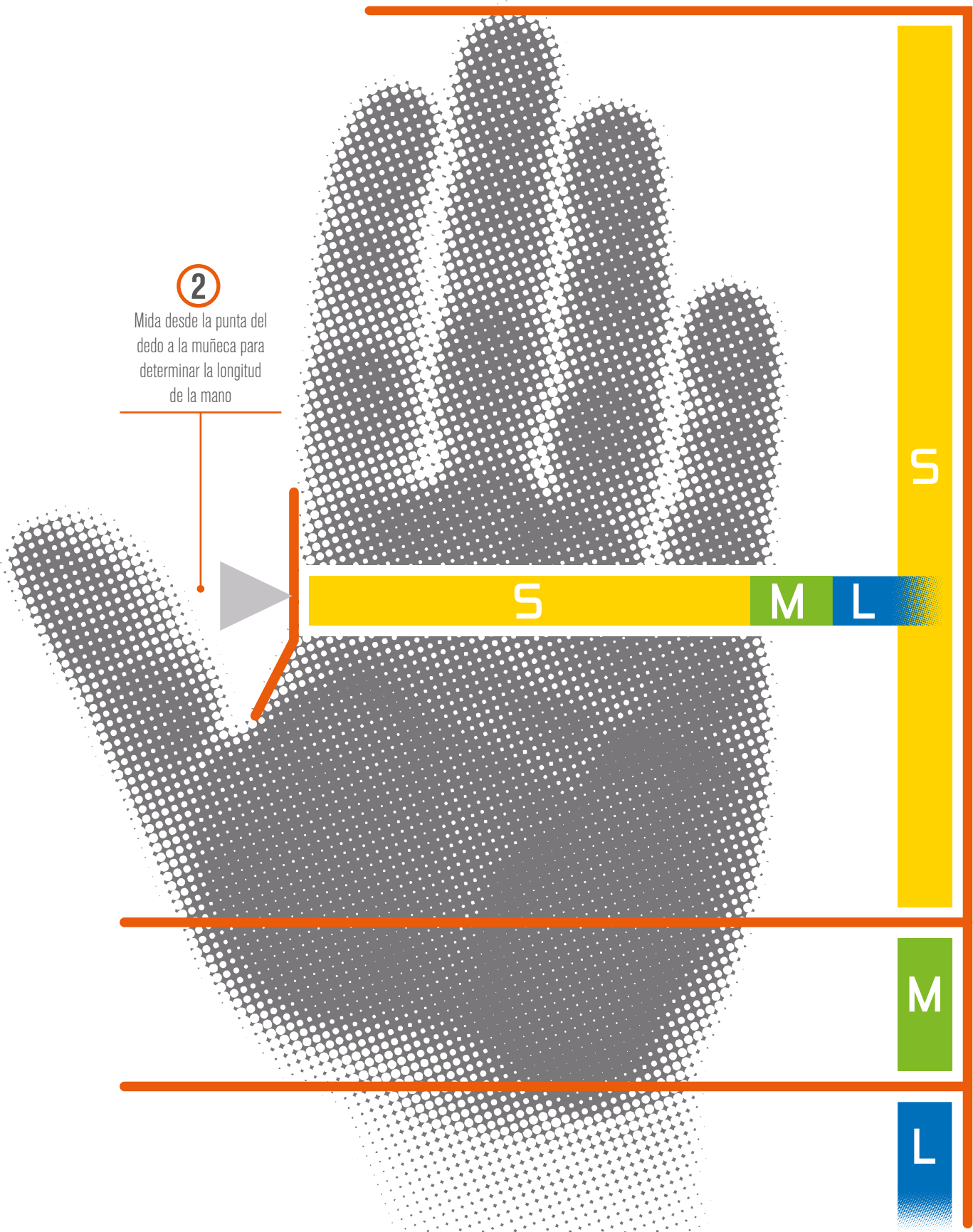

DIFERENTES APLICACIONES

Tipo de podadora		Recomendación de uso	Cabeza de corte	Para zurdos	Capacidad de corte				Heavy Duty	Super ligero	Panel de confort			Repuestos disponibles	
		*** Altamente recomendada ** Recomendada * Aceptable			15 mm 1/2"	20 mm 3/4"	25 mm 1"	30 mm 1 1/4"							
Viticultura															
	PX-S (gama)	***	✓			✓	✓							✓	
	PX-M (gama)					✓	✓		✓						✓
	PX-L (gama)						✓		✓						
	PX-S (gama)	***	✓			✓	✓							✓	
	PX-M (gama)					✓	✓		✓						✓
	PX-L (gama)						✓		✓						
	P1-20	**	✓			✓								✓	
	P1-23								✓						
	P108-20-F	*	✓			✓						✓		✓	
	P108-23-F								✓						
	P110-20-F	*	✓			✓				✓		✓		✓	
	P110-23-F								✓						
	P121-18-F	*	✓			✓				✓		✓			
	P121-20-F								✓						
	P121-23-F								✓						
	P126-19-F	*	✓			✓				✓					
	P126-22-F								✓						
Fruticultura															
	P1-20	***	✓			✓								✓	
	P1-23								✓						
	P110-20-F	***	✓			✓				✓		✓		✓	
	P110-23-F								✓						
	PX-S (gama)	**	✓			✓	✓							✓	
	PX-M (gama)					✓	✓		✓						
	PX-L (gama)						✓		✓						
	PX-S (gama)	**	✓			✓	✓							✓	
	PX-M (gama)					✓	✓		✓						
	PX-L (gama)						✓		✓						
	P108-20-F	**	✓			✓						✓		✓	
	P108-23-F								✓						
	P108-20-F	*	✓			✓				✓				✓	
	P108-23-F								✓						
Paisajismo															
	P1-20	***	✓			✓								✓	
	P1-23								✓						
	P110-20-F	**	✓			✓				✓		✓		✓	
	P110-23-F								✓						
	P3-20-F	**	✓			✓				✓		✓		✓	
	P3-23-F								✓						
	P5-20-F	**	✓			✓				✓		✓		✓	
	P5-23-F								✓						
	P108-20-F	*	✓			✓						✓		✓	
	P108-23-F								✓						
	P121-18-F	*	✓			✓				✓		✓			
	P121-20-F								✓						
	P121-23-F								✓						
	P126-19-F	*	✓			✓				✓					
	P126-22-F								✓						

TIJERAS DE RECOLECCIÓN

Las tijeras de recolección de Bahco se adaptan a cualquier tarea gracias a su manejabilidad y ligereza. Las tijeras tienen unos cómodos mangos de fibra de carbono y vidrio. Éstas se presentan con una funda ligera y están disponibles en diferentes unidades de embalaje.

4 DIFERENTES CABEZAS DE CORTE

P123

Cabeza de corte deslizante larga y delgada.



P127

Hojas cortas y con punta redondeada para mayor seguridad, con apertura limitada.



P128

Hojas largas, delgadas y rectas. Gran apertura.



P129

Misma hoja que la P128 pero con inclinación de 11° para mejor accesibilidad a zonas difíciles.



PODADERAS DE DOS MANOS

Sistema de fijación para el perno central



Mangos de aluminio ligeros, resistentes y extremadamente fuertes, para una poda perfecta

Suaves empuñaduras negras

Sistema de fijación para el perno central

DIFERENTES CABEZAS DE CORTE



Modelo P114

- Cabeza de corte estrecha para podas en espacios reducidos.



Modelo P116 (P116, P19, P16)

- Hoja grande curvada con contrahoja con pronunciada forma de gancho.
- Diseñada para podar a una altura por debajo de la cintura, próxima al suelo.



Modelo P160

- Hoja estrecha combinada con contrahoja con pronunciada forma de gancho.
- Podadera de dos manos diseñada para podar a una altura por encima de la cintura.

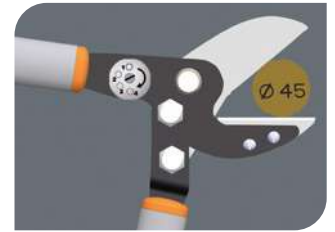

Modelo P173

- Hoja resistente con recubrimiento antifricción (Xylan®) con yunque reemplazable.
- Acción multiplicadora para facilitar la poda en maderas maduras y secas.

CARACTERÍSTICAS ESPECIALES

BISEL EVOLUTIVO

La evolución de la tecnología de bisel es la última mejora del corte deslizante. Un perfil único de la hoja que refuerza el movimiento de corte y facilita la penetración en la madera, especialmente al inicio del corte. Esto da al usuario una sensación de facilidad, rapidez y eficiencia durante las actividades de poda. La tecnología de bisel evolutivo es exclusivo para Bahco Pradines y utilizado en la gama P116-SL.

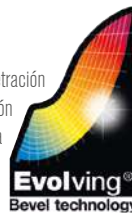

SISTEMA DE ACCIÓN DE PALANCA EN LAS PODADERAS P173 Y P280

Cortar las ramas más grandes y más profundas requiere una fuerza significativa. Las podaderas especiales "asistidas por palanca" que han sido desarrolladas permiten la apertura máxima de la hoja y requieren menos esfuerzo para el mismo efecto de corte.



SISTEMA DE AJUSTE EN LA PODADERA DE DOS MANOS P173



El sistema de ajuste de la podadera P173-SL-85 incrementa el tiempo de vida hasta 4 veces. Debido a la fuerte fuerza de corte se el contacto entre la cuchilla y el yunque se pierde. Moviéndolo al siguiente posición, la cuchilla vuelve a tocar el yunque. El resultado es un corte más limpio.

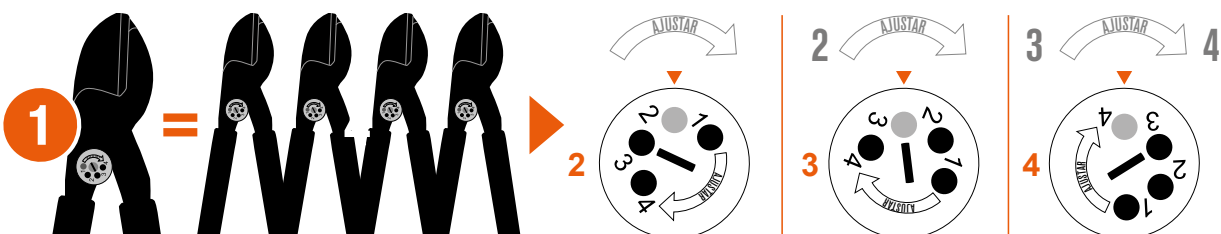

DIFERENTES APLICACIONES

Tipo de podadera	Recomendación de uso	Cabeza de corte	Tipo de cabeza de corte				Capacidad de corte					Heavy Duty	Super ligero	Panel de confort			Repuestos disponibles	
			Mod. 114	Mod. 116	Mod. 160	Mod. P173	25-30 mm	30-35 mm	35-40 mm	40-45 mm	45-50 mm			HD	LIGHT	Panel 1		Panel 2
	*** Altamente recomendada ** Recomendada * Aceptable						1 1/4"	1 1/4" 1 3/8"	1 3/8" 1 1/2"	1 1/2" 1 3/4"	1 3/4" 2"							
Viticultura																		
P114 (gama)	***		✓	✓			✓						✓				✓	✓
P116 (gama)	***		✓		✓				✓				✓				✓	✓
P16 (gama)	**		✓		✓				✓			✓			✓			✓
Fruticultura																		
P116 (gama)	***		✓		✓				✓				✓				✓	✓
P160 (gama)	***		✓			✓				✓			✓				✓	✓
P173-SL-85	**			✓			✓				✓	✓	✓				✓	✓
P16 (gama)	**		✓		✓				✓						✓			✓
P114 (gama)	*		✓		✓			✓					✓				✓	✓
P280-SL-80	*		✓		✓						✓	✓	✓				✓	✓
Paisajismo																		
P19-80-F	***		✓			✓						✓	✓				✓	✓
P173-SL-85	***			✓			✓					✓	✓	✓			✓	✓
P280-SL-80	***		✓			✓						✓	✓	✓			✓	✓
P160 (gama)	**		✓			✓				✓			✓				✓	✓
P16 (gama)	**		✓		✓				✓						✓			✓
Forestal																		
P19-80-F	***		✓			✓						✓	✓				✓	✓
P173-SL-85	***			✓			✓					✓	✓	✓			✓	✓
P280-SL-80	**		✓			✓						✓	✓	✓			✓	✓



PODA EN ALTURA

La prioridad cuando se poda en altura es siempre la seguridad de los trabajadores, así como de las personas cercanas y de las instalaciones. También hay conciencia de la necesidad de proteger el árbol, y seguir las pautas que reflejen prioridades económicas, ambientales y preventivas. La poda en altura Bahco ofrece una poda más fácil y segura en altura con un sistema modular:

PÉRTIGAS

Una sección: hasta 3.400 mm



Empuñadura suave de PVC con un agarre anti-deslizante para mayor comodidad

Reforzado para evitar roturas

De aluminio, fácil manejo gracias a la forma redondeada

Fácil conexión entre secciones.
Fácil inserción de podaderas y serruchos

ASP-1850G + ASP-1850 + ASP-1850 : 7000 mm

HERRAMIENTAS RECOMENDADAS PARA CONECTAR A LA PÉRTIGA



PÉRTIGA TELESCÓPICA

PÉRTIGA LIGERA DE ALUMINIO, ESPECIALMENTE INDICADA PARA PODA CON TREPA











EXTENSIBLE 1100 MM – 2100 MM



HERRAMIENTAS RECOMENDADAS PARA CONECTAR A LA PÉRTIGA



RECOMENDACIÓN DE USO POR TIPO O DENTADO

	Hoja	TPI	 Ø cm	2	4	8	12	16	+
	33-F	7							
	36-M	6							
	39-C	5							
	45-C	5							

DENTADO JT



FINO



MEDIO







GRUESO

Ángulo de corte de 50°, triple afilado, dientes largos con garganta estrecha, sin triscado pero con diferente grosor en la hoja. Dependiendo de la longitud de la hoja, disponible en corte fino, medio o grueso





DIFERENTES APLICACIONES

Tipo de serrucho	Recomendación de uso *** Altamente recomendada ** Recomendada * Aceptable	Dentados				Tipo de corte			Tipo de mango		Repuestos disponibles
		JT	JS	XT	Standard	Fino	Medio	Grueso	Agarre mano	Para pértigas	

Paisajismo

ASP-AS-C33-JT-F 	***	✓				✓				✓	AS-C33-JT-F
ASP-AS-C36-JT-M 	***	✓					✓			✓	AS-C36-JT-M
ASP-AS-C39-JT-M 	***	✓						✓		✓	AS-C39-JT-C
ASP-AS-C45-JT-M 	***	✓						✓		✓	AS-C45-JT-C

Forestal

ASP-AS-C33-JT-F 	***	✓				✓				✓	AS-C33-JT-F
ASP-AS-C36-JT-M 	***	✓					✓			✓	AS-C36-JT-M
ASP-AS-C39-JT-M 	***	✓						✓		✓	AS-C39-JT-C
ASP-AS-C45-JT-M 	***	✓						✓		✓	AS-C45-JT-C

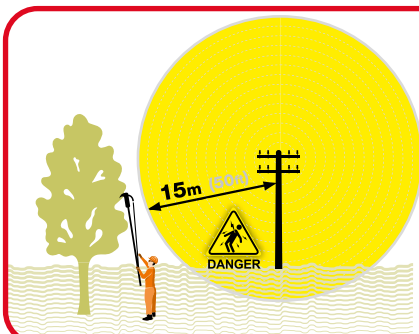

NO UTILIZAR NUNCA A MENOS DE 15 METROS DE LÍNEAS DE ALTA TENSIÓN O CABLES ELECTRIFICADOS. NO RESPETAR ESTA ADVERTENCIA PUEDE DESENCADENAR EN LESIONES GRAVES O MUERTE POR ELECTROCUCIÓN



SERRUCHOS DE PODA

HOJAS JT

DENTADO JT

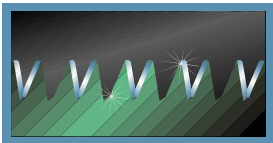

Ángulo de corte de 50°, triple afilado, dientes largos con garganta estrecha, sin triscado pero con diferente grosor en la hoja.



HOJAS JS

DENTADO JS

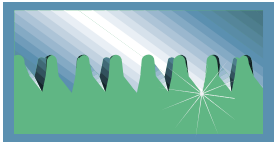

Ángulo de corte de 45°, gargantas anchas para la extracción de astillas de madera, cuchilla de corte cóncava con diseño de diente patentado para un corte muy rápido y agresivo



HOJAS XT

DENTADO XT

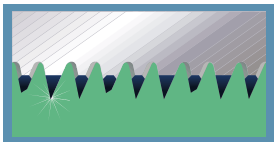











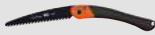



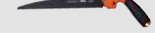



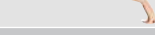

Forma triangular, cada tercer diente se corta y se ajusta para ayudar en la eliminación de las virutas de madera fuera del corte



HOJAS UNIVERSALES

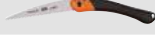

DIFERENTES APLICACIONES

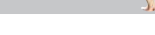
Tipo de serrucho	Recomendación de uso *** Altamente recomendada ** Recomendada * Aceptable	Dentados				Tipo de corte			Tipo de mango		Repuestos disponibles
		JT	JS	XT	Standard	Fino	Medio	Grueso	Agarre mano	Para pértigas	
Viticultura											
396-JT 	***	✓							✓		396-JT-BLADE
396-HP 	**			✓					✓		396-HP-BLADE
396-JS 	*		✓						✓		396-JS-BLADE
Fruticultura											
4124-JT-H 	***	✓							✓		4724-JT
4128-JT-H 	***	✓							✓		4728-JT
396-JT 	***	✓							✓		396-JT-BLADE
5124-JS-H 	**		✓						✓		5724-JS
5128-JS-H 	**		✓	✓					✓		5728-JS
396-JS 	**		✓						✓		396-JS-BLADE
396-HP 	**			✓					✓		396-HP-BLADE
Paisajismo											
4211-11-6T 	**				✓				✓		4420-11
4211-14-6T 	**				✓				✓		4420-14
396-JS 	***		✓						✓		396-JS-BLADE
396-HP 	**			✓					✓		396-HP-BLADE
396-JT 	*	✓							✓		396-JT-BLADE
383-6T 	*				✓				✓	✓	-
386-6T 	*				✓					✓	-
Forestal											
4124-JT-H 	*	✓							✓		4724-JT
4128-JT-H 	*	✓							✓		4728-JT
5124-JS-H 	*		✓						✓		5724-JS
5128-JS-H 	*		✓						✓		5728-JS
396-JS 	*		✓						✓		396-JS-BLADE
396-HP 	*			✓					✓		396-HP-BLADE
396-JT 	*	✓							✓		396-JT-BLADE
4211-11-6T 	*				✓				✓		4420-11
4211-14-6T 	*				✓				✓		4420-14



BCL23

**TRABAJA TODO EL DÍA
CON GRAN FACILIDAD Y
ALTA PRECISIÓN**

Nuestras potentes tijeras de podar BCL23 son la referencia para la poda intensiva de la viña, permitiéndote podar eficazmente con un alto nivel de comodidad, precisión y con una potencia de corte excepcional, convirtiendo la poda pesada en un trabajo ligero. Corta sin esfuerzo desde ramas pequeñas a gruesas y desde madera blanda a muy dura.



BCL2B1

Las tijeras de podar BCL23 vienen con una batería de 147 Wh. El sistema de transporte, cómodo y respetuoso con la espalda, se conecta fácilmente al cinturón con el clip.

Tijera para trabajos pesados
BCL24/BCL23



Diseño robusto y resistente

Orificio de engrase y sistema de bloqueo de tuercas para facilitar el mantenimiento

Corte progresivo con dos aperturas de hoja

La funda está fabricada con un material resistente al desgaste. Sujeta las tijeras de podar de forma segura cuando no se utilizan. Tiene una abertura en la parte superior para sujetarla al cinturón. Diseñada para llevarla tanto en la cadera derecha como en la izquierda.



Ø 35 mm
Ø 23 mm



880 g



43.2 V - 3.4 Ah
Salida
147 Wh
Autonomía
8-10 h
1,050 g



Tiempo de carga
90 min



USB
Fuente de energía



ACCESORIOS Y RECAMBIOS

Hoja	BCL2304
Contrahoja	BCL2305
Afilador	SHARP-X LS-CORINDON
Grasa de litio	BCL2LGRE
Grasa	BCL2GR
Cargador	BCL2C1



INCLUYE



Cinturón
(BCL23)
BCL2BE



Funda
(BCL23 & BCL24)
BCL2HOL

TRABAJA UN DÍA ENTERO CON LA BATERÍA DE LITIO DE 43,2V

La batería ofrece una potencia de corte excepcional y permite un uso intensivo de las tijeras de podar. El bajo consumo de energía de la batería en combinación con el motor sin escobillas de alto rendimiento de las tijeras de podar proporciona un uso de al menos un día completo de trabajo. La unidad de control integrada es fácil de entender, muestra el número de cortes y la carga de la batería.

Hoja de acero japonés SK5 cromado de alta calidad

- Mantiene el filo
- Fricción reducida
- Excelente resistencia al desgaste y a la oxidación

Mango antideslizante de agarre suave para un mejor agarre y comodidad

Cómoda empuñadura adecuada tanto para la mano izquierda como para la derecha

Gatillo progresivo preciso para controlar el movimiento



Brazaletes (BCL23 & BCL24)
BCL2AB



Arnés (BCL24)
BCL20H

BCL24

CORTA MADERA GRUESA E INCLUSO LA MÁS DURA CON FACILIDAD

Nuestras potentísimas tijeras de podar BCL24 son la referencia cuando se trata de cortar y podar madera muy gruesa y dura. Las tijeras de podar proporcionan una excelente potencia de corte, un acabado muy limpio del corte y permiten realizar cortes precisos incluso en madera excepcionalmente dura. Convierten la poda pesada en un trabajo ligero, especialmente en la poda de frutales de hueso, olivos, cítricos y nogales.

Las tijeras de podar BCL24 incluyen una batería de 294 Wh. El cómodo arnés de transporte se adapta a múltiples tamaños.



Ø 45 mm
Ø 30 mm



1,020 g



43.2 V - 6.8 Ah
Salida
294 Wh
Autonomía
8-10 h
1,900 g

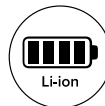

Tiempo de carga
200 min

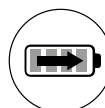

USB
Fuente de energía



ACCESORIOS Y RECAMBIOS

Hoja	BCL2404
Contrahoja	BCL2405
Afilador	SHARP-X LS-CORINDON
Grasa de litio	BCL2LGRE
Grasa	BCL2GR
Cargador	BCL2C1

TIJERAS DE PODAR INALÁMBRICAS DE ÚLTIMA GENERACIÓN

Nuestra nueva generación de tijeras de podar sin cable te lleva al siguiente nivel de experiencias de poda, ya sea cuando se trabaja en viñedos, huertos o jardines ornamentales.

Incorpora motores sin escobillas de último diseño con electrónica avanzada para una potencia infinita y una velocidad de corte excepcional. La hoja de acero SK5 de alta calidad viene con un recubrimiento de polímero para una mayor durabilidad y protección contra el óxido.

¡NOVEDAD!



POTENCIA

Potencia de corte infinita gracias al motor sin escobillas con electrónica avanzada



VELOCIDAD

Mayor velocidad de corte para maximizar la eficiencia y aumentar su productividad.



HOJA

Nueva y resistente hoja de acero SK5 forjada de una sola pieza para una mayor durabilidad y un menor mantenimiento. El revestimiento de polímero proporciona una mayor resistencia a la corrosión y baja fricción para una mayor autonomía de la batería.



AJUSTE DE LAS HOJAS

Aumenta la vida útil de las hojas utilizando el nuevo sistema de control de cruce.



SENSIBILIDAD AUMENTADA DEL GATILLO

Corte progresivo, control extremo del corte. Elige fácilmente la capacidad de corte deseada:

- **Opción 1:** Cierra las hojas durante un segundo para elegir entre las dos aperturas de hoja preajustadas
- **Opción 2:** Utiliza el gatillo progresivo para seleccionar cualquier capacidad de corte deseada para maximizar la eficacia. Mantén pulsado durante un segundo la apertura de hoja deseada



BCL226



BCL235



BCL240

BCL226

PODA LIGERA HASTA 26 MM

Nuestras tijeras de podar super compactas **BCL226** son ideales para poda rápida y suave de pequeñas vides y ramas finas.

Hoja de acero SK5 de alta calidad. Recubrimiento de polímero extra resistente al desgaste y a la corrosión.

ACCESORIOS Y RECAMBIOS

Hoja	BCL22604
Contrahoja	BCL22605
Grasa de litio	BCL2LGRE
Grasa	BCL2GR
Cargador	BCL226C
Afilador	SHARP-X LS-CORINDON



¡NOVEDAD!



Ø 26 mm
Ø 15 mm



920 g
Batería incluida

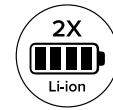

2X
10.8 V - 2.5 Ah
Salida 27 Wh
Incluye 2 baterías

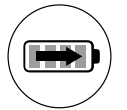

Tiempo de carga
90 min
Conexión doble

ACCESORIOS (opcionales)



Funda para batería
(para BCL226B & BCL1B031B)
BCL20BP



Funda
(para BCL226 & BCL235)
BCL2HOL



BCL235

MAXIMIZA TU LIBERTAD DE MOVIMIENTOS

Nuestras tijeras de podar compactas **BCL235IB** son ideales para la poda ligera de enredaderas, así como de arbustos y pequeños árboles ornamentales.

Hoja de acero SK5 forjado de una sola pieza de alta calidad. Recubrimiento de polímero extra resistente al desgaste y a la corrosión.

ACCESORIOS Y RECAMBIOS

Hoja	BCL23504
Contrahoja	BCL23505
Grasa de litio	BCL2LGRE
Grasa	BCL2GR
Cargador	BCL1C4IB
Afilador	SHARP-X LS-CORINDON



Ø 35 mm
Ø 18 mm



970 g
Batería incluida

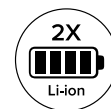

2X
14.4 V - 2.5 Ah
Salida 36 Wh
Incluye 2 baterías

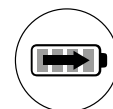

Tiempo de carga
90 min
Conexión doble

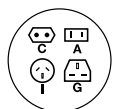

4 adaptadores
de corriente

¡NOVEDAD!

BCL240

MANTÉN LA VANGUARDIA EN HUERTOS Y JARDINES

Con nuestra **BCL240** podarás cómodamente frutales de pepita y árboles ornamentales grandes o maduros.

Hoja de acero SK5 forjado de una sola pieza de alta calidad. Recubrimiento de polímero extra resistente al desgaste y a la corrosión.



¡NOVEDAD!

ACCESORIOS (opcionales)



Funda para batería
(para BCL240)
BCL25BP



Funda
(para BCL240)
BCL2HOL

ACCESORIOS Y RECAMBIOS

Hoja	BCL24004
Contrahoja	BCL24005
Grasa de litio	BCL2LGRE
Grasa	BCL2GR
Cargador	BCL1C5IB
Afilador	SHARP-X LS-CORINDON



Ø 40 mm
Ø 27 mm



1,230 g
Batería incluida



21.6 V - 2.5 Ah
Salida 54 Wh
Incluye 3 baterías



Tiempo de carga
150 min
Conexión triple



4 adaptadores
de corriente

BCL25TP

LLEGA MÁS ALTO SIN COMPROMETER LA SEGURIDAD

Las tijeras de podar **BCL240** pueden acoplarse fácilmente a nuestra pértiga telescópica **BCL25TP** cuando se necesita un mayor alcance. Con esta robusta pértiga de aluminio podrás podar con seguridad y facilidad hasta 4,3 metros de altura.

PÉRTIGA TELESCÓPICA BCL25TP (OPCIONAL)

Peso 1,350 g



2,200 M

Pértiga telescópica
BCL25TP

1,500 M

MAX. 4,300 M

BCL15IB

CORTA RAMAS GRUESAS SIN ESFUERZO

Compacta pero potente, nuestra motosierra **BCL15IB** ofrece una capacidad de corte excepcional y permite cortar sin esfuerzo ramas muy gruesas e incluso árboles pequeños de hasta 110 mm de diámetro, ya sea en huertos, viñedos o espacios verdes. Gracias a su diseño ligero, la **BCL15IB** también permite cortar cómodamente por encima de la cabeza.

CAPACIDAD DE CORTE: 110 MM
VELOCIDAD DE CORTE: 11 M/S



600W

ACCESORIO (opcional)



Funda
(para BCL15IB)
BCL15HOL

RECAMBIOS

Barra de cadena	BCL1502
Cadena de 38 dientes 1/4"	BCL1503



110 mm
Velocidad
11 m/s



1,800 g



38 dientes 1/4"

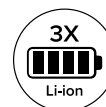

21.6 V - 4.2 Ah
90.7 Wh
Incluye 3 baterías

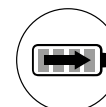

Tiempo de carga
270 min
Conexión triple

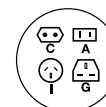

4 adaptadores
de corriente

DOS GRANDES COMBINACIONES DE MOTOSIERRA CON TIJERAS DE PODAR

La motosierra **BCL15IB** y nuestras tijeras de podar **BCL24** son la combinación ideal para la poda intensiva de olivos. La motosierra puede alimentarse con las baterías de las tijeras de podar mediante un cable de conexión.

La motosierra **BCL15IB**, combinada con nuestras tijeras de podar **BCL240**, es una pareja ideal para podar y cortar árboles frutales. Las baterías de las tijeras de podar **BCL240** y la motosierra **BCL15IB** son fácilmente intercambiables.



IDEAL PARA LA PODA
DE OLIVOS



BCL15IB Motosierra
+ tijeras de podar **BCL24**



IDEAL PARA LA PODA
DE ÁRBOLES FRUTALES



BCL15IB Motosierra
+ tijeras de podar **BCL240**



BCL52TP / BCL52FP

MAXIMIZA LA EFICIENCIA EN LA COSECHA DE ACEITUNAS

Nuestros vareadores de aceitunas BCL52FP y BCL52TP, ligeros y fáciles de maniobrar, con potentes motores sin escobillas, garantizan un funcionamiento sin problemas durante la recolección de aceitunas.

La combinación adecuada de selección de materiales, peso, equilibrado y vibración no sólo minimiza el impacto sobre las aceitunas y las ramas, sino que también tiene un efecto positivo sobre la salud de los usuarios, que suelen estar expuestos a diversos riesgos musculoesqueléticos causados por las altas vibraciones de las sacudidoras.

BCL52TP

- Pértiga telescópica de fibra de carbono con longitud ajustable de 2.160-2.960 mm
- Alcance máximo de trabajo de 600 mm con los peines abiertos
- Mínimo esfuerzo de vibración para aceitunas y ramas

BCL52FP

- Pértiga fija de fibra de carbono de 2.500 mm con extensión adicional de 700 mm
- Alcance máximo de trabajo de 600 mm con los peines abiertos
- Mínimo esfuerzo de vibración para aceitunas y ramas

ACCESORIOS Y PIEZAS DE RECAMBIO BCL52TP & BCL52FP

Pack de baterías (arnés, cargador, cable)	BCL5B1PACK
Batería (solo)	BCL5B1
Convertidor de 12 V	BCL52CNV
Aarnés	BCL5H
Cargador	BCL5C1

ELIGE LA OPCIÓN DE ALIMENTACIÓN QUE SE ADAPTE A TUS NECESIDADES

Nuestros vareadores de aceitunas BCL52FP y BCL52TP pueden funcionar con nuestra batería de 36 V BCL5B1 o, con nuestro convertidor de 36 V a 12 V BCL52CNV, con un sistema de batería de coche de 12 V. El sistema de batería de coche de 12 V puede cargarse fácilmente con el cargador automático BBCE12-6.

BCL52TP & BCL52FP



5 + 5 de carbono
330 mm
BCL5201



5 niveles de velocidad de 950 BPM a 1.200 BPM



600 mm



BCL52TP

2,250 g
Potencia máxima 700W
Alimentación del motor 36 V
(Max 43 V)

BCL52FP

1,900 g (sin extensión)
Potencia máxima 700W
Alimentación del motor 36 V
(Max 43 V)

+ EXTENSIÓN
2,500 mm > 3,200mm

+ EXTENSIÓN
2,300 mm > 3,300mm



BCL51

2,200 g (sin extensión)
Potencia máxima 370W
Alimentación del motor 12 V



Alcance de trabajo 600 mm
2 x 5 varillas flexibles de fibra de carbono de 330 mm
En forma de ala de gaviota - dos peines
con movimiento opuesto (400 mm - BCL51)

BCL51

BENEFÍCIATE DE UNA GRAN SELECCIÓN DE PRÁCTICAS FUNCIONES

Nuestro vareador de aceitunas **BCL51** ofrece todas las funciones esenciales y es una excelente elección para realizar fácilmente todas las tareas más comunes en la recolección de aceitunas. Con su robusta pértiga de aluminio de 2.300 mm y su extensión adicional de 1.000 mm, permite trabajar cómodamente a mayor altura. El vareador de aceitunas BCL51 se suministra con un cable de alimentación de 14 m para funcionar con un sistema de batería de coche de 12 V.

- Pértiga fija de aluminio de 2.300 mm
- Incluye una extensión de aluminio de 1.000 mm

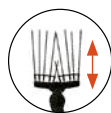

5 + 5 de carbono
2 x 120 mm
8 x 275 mm
BCL5101



1,650 BPM

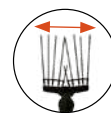

400 mm

FUENTE DE ALIMENTACIÓN



BCL52CNV
Convertidor de 36 V a 12 V
BCL52TP & BCL52FP
(opcional)



BCL5B1PACK
720 Wh (20 Ah) para una autonomía de 5 a 6 horas
3,700 g
BCL52TP & BCL52FP
(opcional)



BBCE12-6
Cargador de 6A para baterías de 12V
1,190 g
BCL52TP & BCL52FP
(opcional)



CABLE DE ALIMENTACIÓN
para 12V - 14 metros
BCL5115
(incluido)

MAYOR POTENCIA, MAYOR RENDIMIENTO

ESTÁ EN NUESTRO ADN: HERRAMIENTAS DE PODA, CORTE Y RECOLECCIÓN PARA PROFESIONALES

Llevamos fabricando herramientas desde 1886, y un profundo conocimiento de las necesidades y experiencias de las personas que trabajan con nuestras herramientas día a día está en nuestro ADN.

Basados en una amplia investigación y en una tecnología avanzada, nuestras tijeras de poda eléctricas, motosierra, y vareadores de aceitunas están diseñados por profesionales, para profesionales.

Al ofrecer un rendimiento y una eficiencia sostenidos e incomparables, así como comodidad y seguridad, nuestras herramientas te facilitarán el trabajo en tu viñedo, huerto o jardín ornamental. Nuestras herramientas son el siguiente nivel de potencia y satisfacen incluso sus más altas exigencias y aumentan su productividad. Desde la poda ligera hasta el corte muy intensivo y la exigente recolección de aceitunas, nuestra gama está diseñada para una multitud de trabajos de viticultura, fruticultura y actividades de horticultura.

EXPERIMENTA LA POTENCIA Y MAXIMIZA LA EFICIENCIA

Tanto si podas con nuestras tijeras de poda de alta resistencia como con tijeras sin cable, el diseño robusto pero ligero y el motor sin escobillas de alto rendimiento permiten un alto grado de comodidad y precisión, incluso al cortar madera extremadamente dura. Las baterías de Litio de alta calidad de nuestras tijeras de podar ofrecen una excelente capacidad de potencia y permiten un uso prolongado sin interrupción. Sus hojas de acero japonés SK5 de alta calidad garantizan una excelente durabilidad de corte y resistencia a la oxidación. El corte progresivo con dos aperturas de la hoja se adapta totalmente a las necesidades de la aplicación y permite cortar ramas de hasta 45 mm de diámetro. Para las tareas más exigentes, puedes utilizar nuestra nueva motosierra, que corta ramas de hasta 110 mm de diámetro.

La motosierra funciona perfectamente junto con nuestras tijeras de podar sin cable BCL240 o nuestras tijeras de podar de alta resistencia BCL24. La combinación de motosierra y BCL24 es ideal para la poda de olivos. Antes de podar tus olivos, para una cosecha eficiente puedes utilizar nuestra nueva gama de vareadores de aceitunas, que ofrecemos con pértiga fija o telescópica.

**¡MAYOR POTENCIA,
MAYOR RENDIMIENTO!**

SOLUCIONES DE ALIMENTACIÓN

PARA QUE TODO VAYA SOBRE RUEDAS

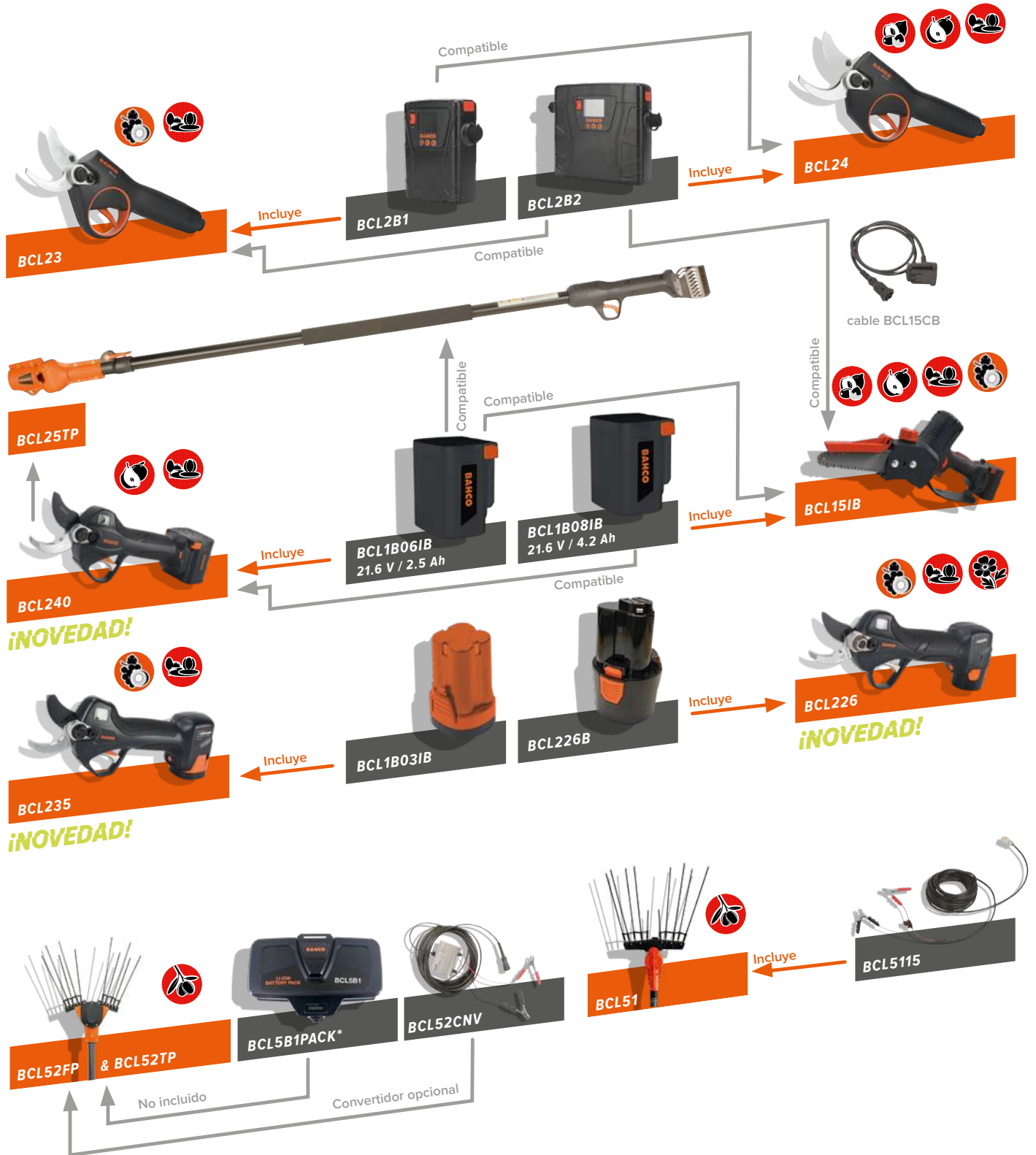

BCL5B1PACK Batería que incluye arnés, cargador y cable de alimentación
 BCL5B1 Batería, sin arnés, cargador ni cable de alimentación

ESPECIFICACIÓN TÉCNICA

BCL24



TIJERAS DE PODAR BCL24

Capacidad de corte total	45 mm
Capacidad de corte mediana	30 mm
Peso (sin batería)	1,020 g

BATERÍA BCL2B2

Tipo de batería	Litio
Peso de batería	1,900 g
Voltaje	43.2 V
Capacidad	6.8 Ah
Potencia almacenada	294 Wh
Tiempo en funcionamiento	8 – 10 horas
Tiempo de carga	200 min

ACCESORIOS Y REPUESTOS

Hoja	BCL2404
Contrahoja	BCL2405
Batería	BCL2B2
Cargador	BCL2C1
Aceite de litio	BCL2LGRE
Funda	BCL2HOL
Afilador	SHARP-X LS-CORINDON

BCL23



TIJERAS DE PODAR BCL23

Capacidad de corte total	35 mm
Capacidad de corte mediana	23 mm
Peso (sin batería)	880 g

BATERÍA BCL2B1

Tipo de batería	Litio
Peso de batería	1,050 g
Voltaje	43.2 V
Capacidad	3.4 Ah
Potencia almacenada	147 Wh
Tiempo en funcionamiento	8 – 10 horas
Tiempo de carga	90 min

ACCESORIOS Y REPUESTOS

Hoja	BCL2304
Contrahoja	BCL2305
Batería	BCL2B1
Cargador	BCL2C1
Aceite de litio	BCL2LGRE
Funda	BCL2HOL
Afilador	SHARP-X LS-CORINDON

BCL226



TIJERAS DE PODAR BCL226

Capacidad de corte total	26 mm
Capacidad de corte mediana	15 mm
Peso (con batería)	920 g

BATERÍA BCL226B

Tipo de batería	Litio
Peso de batería	230 g
Voltaje	14.4 V
Capacidad	2.5 Ah
Potencia almacenada	27 Wh
Tiempo en funcionamiento	2-6 horas
Tiempo de carga	90 min

ACCESORIOS Y REPUESTOS

Hoja	BCL22604
Contrahoja	BCL22605
Batería	BCL226B
Cargador	BCL226C
Aceite de litio	BCL2LGRE
Funda	BCL2HOL
Funda para la batería	BCL20BP

BCL235



TIJERAS DE PODAR BCL235

Capacidad de corte total	35 mm
Capacidad de corte mediana	18 mm
Peso (con batería)	970 g

BATERÍA BCL1B03IB

Tipo de batería	Litio
Peso de batería	230 g
Voltaje	14.4 V
Capacidad	2.5 Ah
Potencia almacenada	36 Wh
Tiempo en funcionamiento	2–8 horas
Tiempo de carga	90 min

ACCESORIOS Y REPUESTOS

Hoja	BCL23504
Contrahoja	BCL23505
Batería	BCL1B03IB
Cargador	BCL1C4IB
Aceite de litio	BCL2LGRE
Funda	BCL2HOL
Funda para la batería	BCL20BP

BCL240



TIJERAS DE PODAR BCL240

Capacidad de corte total	40 mm
Capacidad de corte mediana	27 mm
Peso (con batería)	1230 g

BATERÍA BCL1B06IB

Tipo de batería	Litio
Peso de batería	230 g
Voltaje	21.6 V
Capacidad	2.5 Ah
Potencia almacenada	54 Wh
Tiempo en funcionamiento	3–4 horas
Tiempo de carga	150 min

ACCESORIOS Y REPUESTOS

Hoja	BCL24004
Contrahoja	BCL24005
Batería	BCL1B06IB
Cargador	BCL1C5IB
Aceite de litio	BCL2LGRE
Funda	BCL2HOL
Funda para la batería	BCL25BP

PÉRTIGA TELESCÓPICA BCL25TP (opcional)

Extensible	1.5 m–2.2 m
Peso	1,350 g

Nº	CODE	DESCRIPTION
1	BCL22601	BCL226 BODY
2	BCL22602	CONICAL RIM
3	BCL23503	CENTER BOLT ASSY
4	BCL22604	BLADE
5	BCL22605	COUNTER BLADE
6	BCL226C	CHARGER
7	BCL226B	BATTERY
8	BCL2SPRING	TRIGGER SPRING 10 PCS



BCL226

Revision: 00



*Not numbered parts are supplied by kits but not individually.

*SNA Europe does not cover the causes over negligence in tool use and/or repair, inadequate care, or abnormal usage conditions. Follow the instructions for proper use, safety, maintenance and servicing given by SNA Europe

11072024

Nº	CODE	DESCRIPTION
1	BCL1B031B	BATTERY PACK 2.5AH 36WH
2	BCL1C41B	BATTERY CHARGER 16.8V
3	BCL23503	CENTER BOLT ASSY
4	BCL23504	BLADE CONICAL RIM ASSY
5	BCL23505	COUNTER BLADE
6	BCL23506	TRIGGER ASSY - METAL
7	BCL23507	HALL PCB ASSY
8	BCL23508	MAIN PCB ASSY
9	BCL2SPRING	TRIGGER SPRING 10 PCS
10	23122003	LCD DISPLAY ASSY
11	23122005	BRUSSLESS MOTOR ASSY
12	23122012	ON/OFF BUTTON ASSY
13	23122013	CUTTING HEAD FRAME
14	23122006	PINION ASSY
15	23122007	GEAR BOX ASSY
16	BCL201B16	PLASTIC CASE ASSY- BLACK



BCL235

Revision: 00

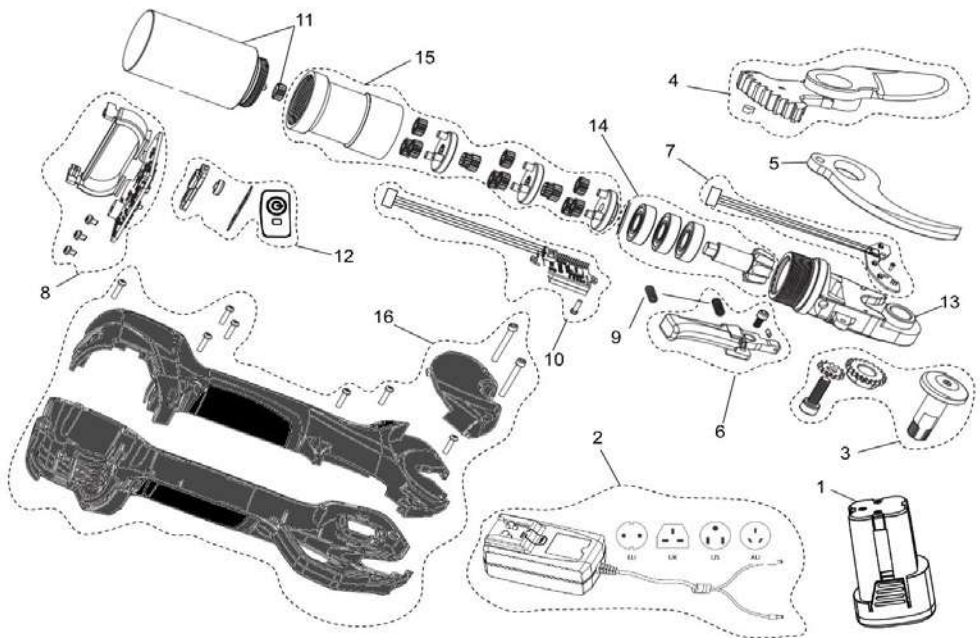

*Not numbered parts are supplied by kits but not individually.

*SNA Europe does not cover the causes over negligence in tool use and/or repair, inadequate care, or abnormal usage conditions. Follow the instructions for proper use, safety, maintenance and servicing given by SNA Europe

11072024



Nº	CODE	DESCRIPTION
1	BCL2501	CASE COVER ASSY
2	BCL24002	DRIVING GEAR ASSY
3	23122003	LCD DISPLAY ASSY
4	BCL24004	BLADE CONICAL RIM ASSY
5	BCL24005	COUNTER BLADE
6	BCL24006	HALL PCB ASSY
7	BCL24007	ENGINE ASSY
8	BCL24008	GEAR BOX ASSY
9	BCL24009	TRIGGER ASSY
10	BCL24010	SMALL BEVEL ASSY
11	BCL24011	BIG SPIRAL BEVEL ASSY
12	BCL24012	MAIN BODY ASSY
13	BCL24013	CENTER BOLT ASSY
14	BCL1C51B	CHARGER
15	BCL1B061B	BATTERY ASSY
16	BCL24016	MAIN PCB
17	BCL2517	POWER BUTTON ASSY
18	BCL2SPRING	TRIGGER SPRING 10 PCS



BCL240

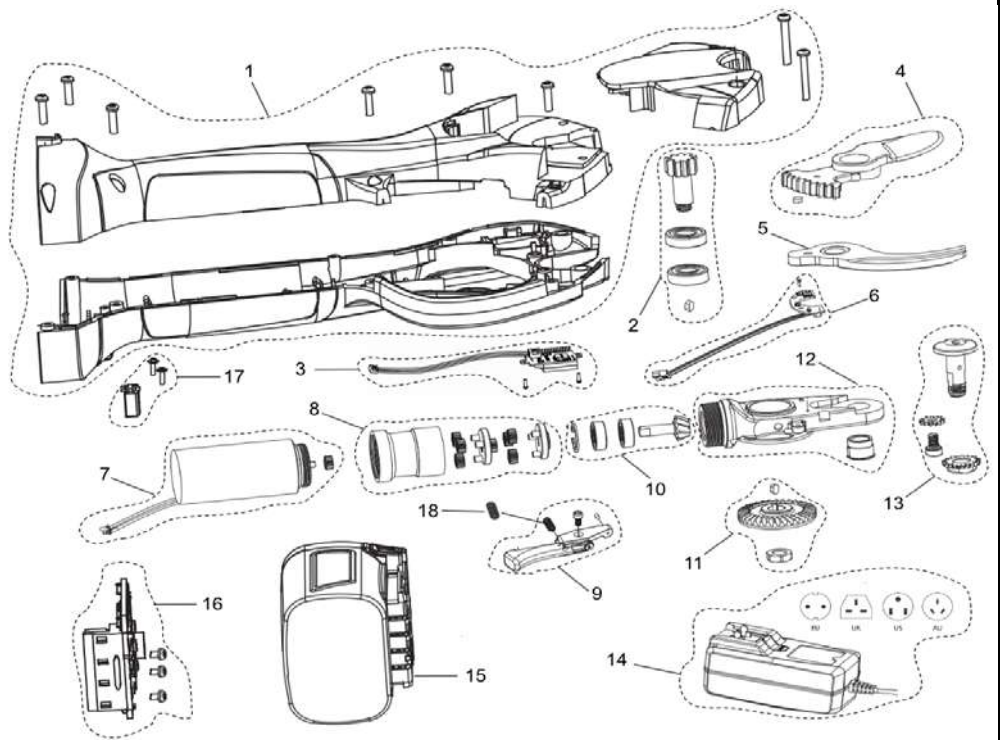

*Not numbered parts are supplied by kits but not individually.

*SNA Europe does not cover the causes over negligence in tool use and/or repair, inadequate care, or abnormal usage conditions. Follow the instructions for proper use, safety, maintenance and servicing given by SNA Europe

Revision: 00

11072024

Nº	CODE	DESCRIPTION
1	BCL2301	CASE COVER ASSY
1B	BCL2301B	RIM PINION COVER ASSY
2	BCL2302	DRIVING GEAR ASSY
3	BCL2303	CONICAL RIM ASSY
4	BCL2304	BLADE ASSY
5	BCL2305	COUNTER BLADE
6	BCL2306	HALL PCB ASSY
7	BCL2307	ENGINE ASSY
8	BCL2308	GEAR BOX ASSY
9	BCL2309	TRIGGER ASSY
10	BCL2310	SMALL BEVEL ASSY
11	BCL2311	BIG SPIRAL BEVEL ASSY
12	BCL2312	MAIN BODY
13	BCL2313	CENTER BOLT ASSY
14	BCL2C1	CHARGER + EU CORD C7
14B	BBBCAB-EU	EU POWER CORD C7
14C	BBBCAB-UK	UK POWER CORD C7
14D	BBBCAB-US	US POWER CORD C7
14E	BBBCAB-AUZ	AUZ POWER CORD C7
15	BCL2B1	BATTERY ASSY
16	BCL2316	CONTROL BOX
17	BCL2317	BATTERY HOLSTER
18	BCL2318	CABLE



BCL23

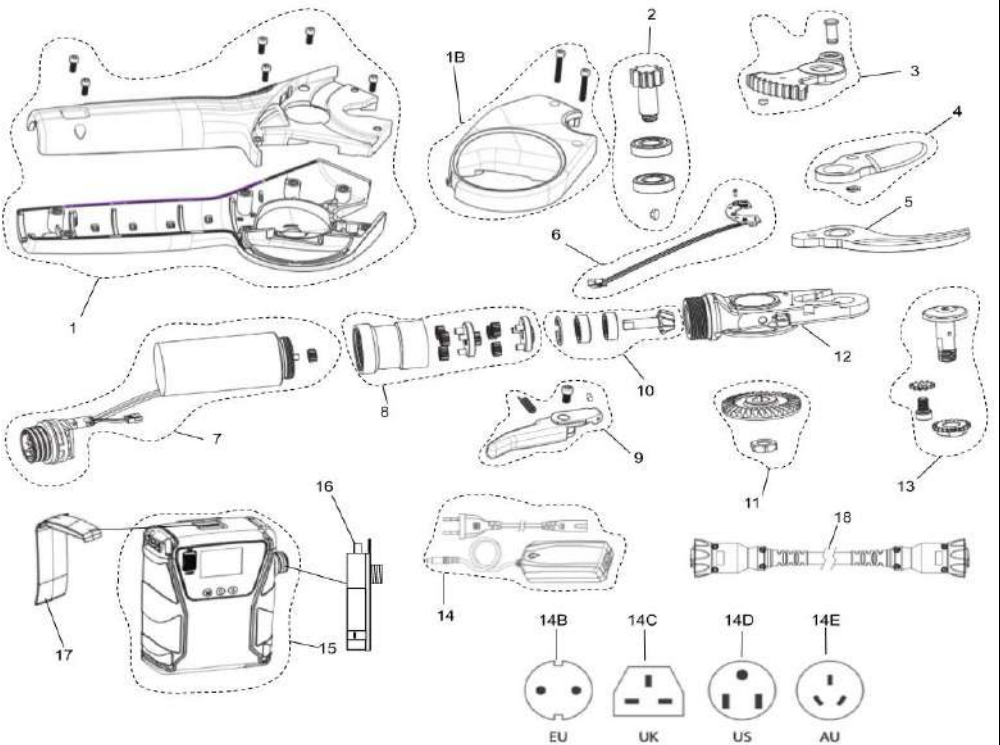

SNA Europe does not cover the causes over negligence in tool use and/or repair, inadequate care, or abnormal usage conditions. Follow the instructions for proper use, safety, maintenance and servicing given by SNA Europe

Revision: 02

17052021

Nº	CODE	DESCRIPTION
1	BCL25TP01	SECATEURS HOUSING ASSY
2	BCL25TP02	BATTERY PROTECTOR ASSY
3	BCL25TP03	MAIN HARNESS ASSY
4	BCL25TP04	HANDLE ASSY
5	BCL25TP05	TRIGGER ASSY
6	BCL25TP06	TRIGGER SENSOR ASSY
7	BCL25TP07	BAR LOCKING ASSY
8	BCL25TP08	ALUMINIUM BARS SET

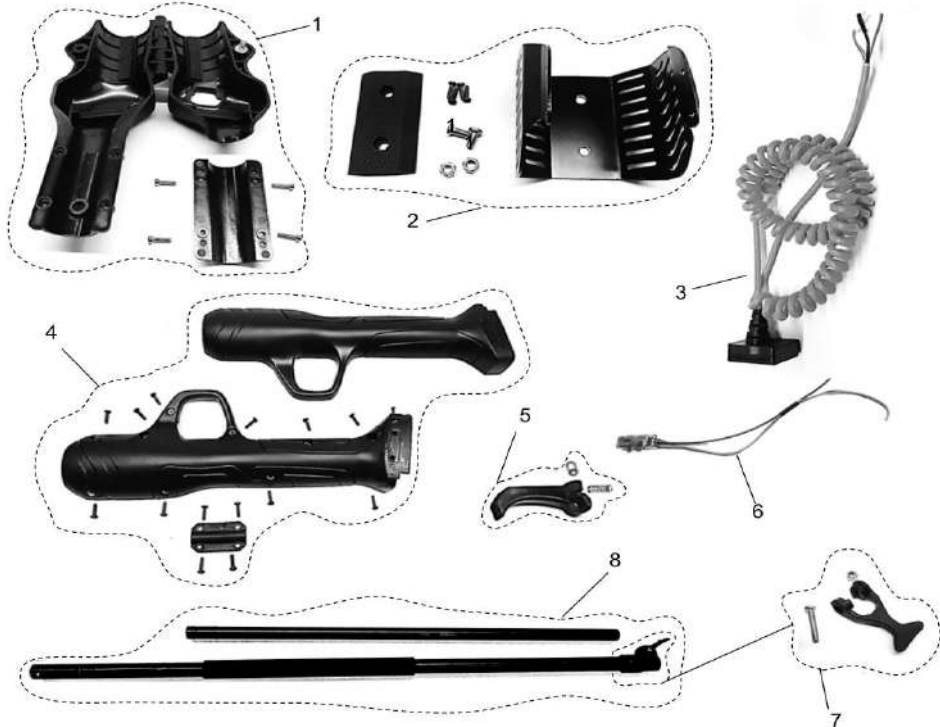

BCL25TP

Revision: 01

SNA Europe does not cover the causes over negligence in tool use and/or repair, inadequate care, or abnormal usage conditions. Follow the instructions for proper use, safety, maintenance and servicing given by SNA Europe

01062021

Nº	CODE	DESCRIPTION
1	BCL2401	CASE COVER ASSY
1B	BCL2401B	RIM PINION COVER ASSY
2	BCL2402	DRIVING GEAR ASSY
3	BCL2403	CONICAL RIMA ASSY
4	BCL2404	BLADE ASSY
5	BCL2405	COUNTER BLADE
6	BCL2406	HALL PCB ASSY
7	BCL2407	ENGINE ASSY
8	BCL2408	GEAR BOX ASSY
9	BCL2409	TRIGGER ASSY
10	BCL2410	SMALL BEVEL ASSY
11	BCL2411	BIG SPIRAL BEVEL ASSY
12	BCL2412	MAIN BODY
13	BCL2413	CENTER BOLT ASSY
14	BCL2C1	CHARGER
14B	BBBCAB-EU	EU POWER CORD C7
14C	BBBCAB-UK	UK POWER CORD C7
14D	BBBCAB-US	US POWER CORD C7
14E	BBBCAB-AUZ	AUZ POWER CORD C7
15	BCL2B2	BATTERY ASSY
16	BCL2316	CONTROL BOX
17	BCL2417	BATTERY HOLSTER
18	BCL2318	CABLE

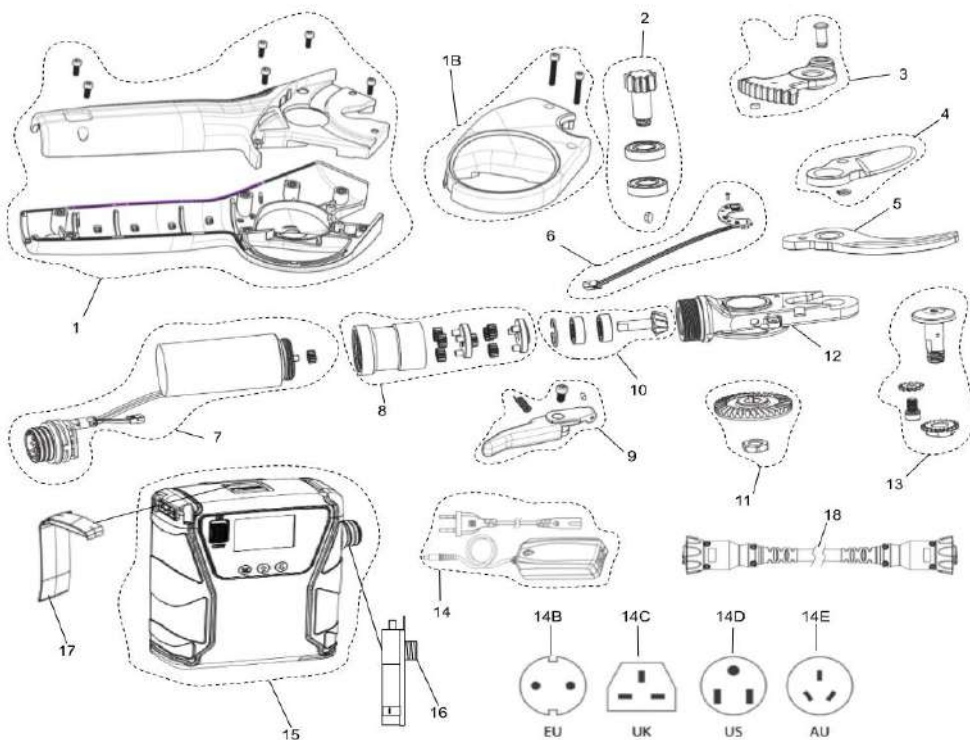

BCL24

Revision: 02

SNA Europe does not cover the causes over negligence in tool use and/or repair, inadequate care, or abnormal usage conditions. Follow the instructions for proper use, safety, maintenance and servicing given by SNA Europe

18052021



Nº	CODE	DESCRIPTION
1	BCL1501	CHAIN PROTECTION COVER ASSY
2	BCL1502	CHAIN GUIDE
3	BCL1503	38 LINK CHAIN
4	BCL1504	SPROCKET ASSY
5	BCL1505	SHIELD ASSY
6	BCL1506	TEETH ASSY
7	BCL1507	TENSION MECHANISM ASSY
8	BCL1508	GEAR BOX ASSY
9	BCL1509	WORM ASSY
10	BCL1510	GASKET
11	BCL1511	OIL PIPE ASSY
12	BCL1512	OIL PUMP ASSY
13	BCL1513	SMALL UMBRELLA ASSY
14	BCL1514	PLASTIC CASE ASSY
15	BCL1515	MOTOR ASSY
16	BCL1516	OIL TANK LID ASSY
17	BCL1517	OIL TANK ASSY
18	BCL1518	TRIGGER BUTTON SWITCH ASSY
19	BCL1519	MAIN PCB ASSY
20	BCL1520	DISPLAY ASSY
21	BCL1808IB	BATTERY ASSY
22	BCL1C5IB	CHARGER

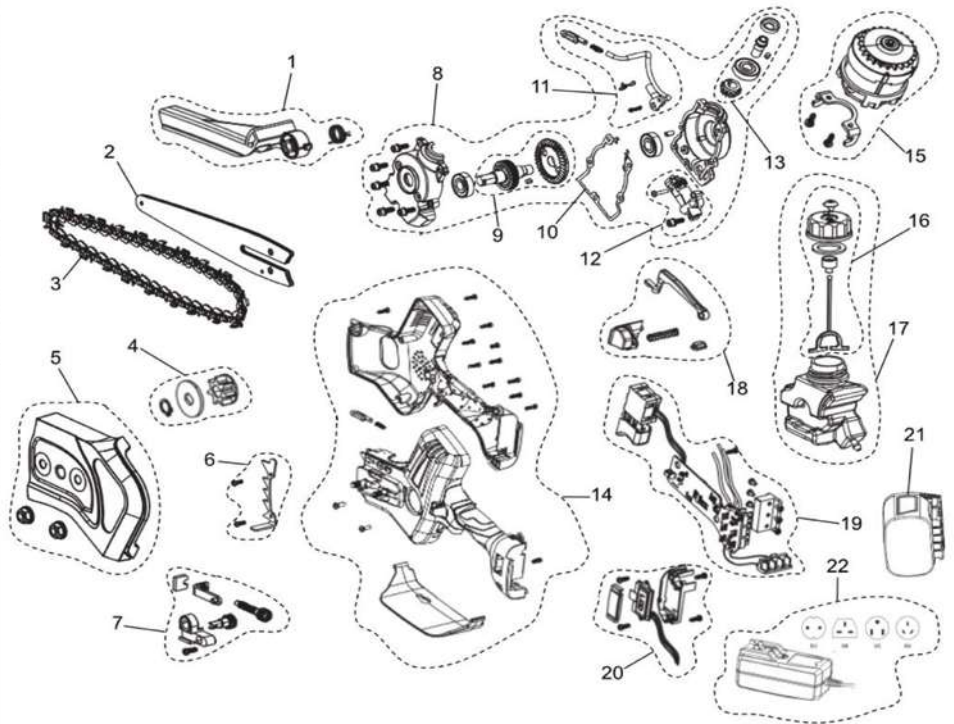

BCL15IB BCL15WB

Revision: 00

SNA Europe does not cover the causes over negligence in tool use and/or repair, inadequate care, or abnormal usage conditions. Follow the instructions for proper use, safety, maintenance and servicing given by SNA Europe

4042022

Nº	CODE	DESCRIPTION
1	BCL5101	CARBON RODS KIT
2	BCL5102	RODS FRAME KIT
3	BCL5103	COMBS KIT
4	BCL5104	GEAR ASSY
5	BCL5105	HEAD PLASTIC CASE ASSY
6	BCL5106	ENGINE ASSY
7	BCL5107	CABLE CONNECTOR ASSY
8	BCL5108	MAIN PIPE 1640MM
9	BCL5109	AUX PIPE 150MM
10	BCL5110	EXTENSION PIPE 1000MM
11	BCL5111	SWITCH
12	BCL5112	15A FUSE
13	BCL5113	INTERNAL WIRING
14	BCL5114	HANDLE CASE ASSY
15	BCL5115	EXTENSION CORD 14M

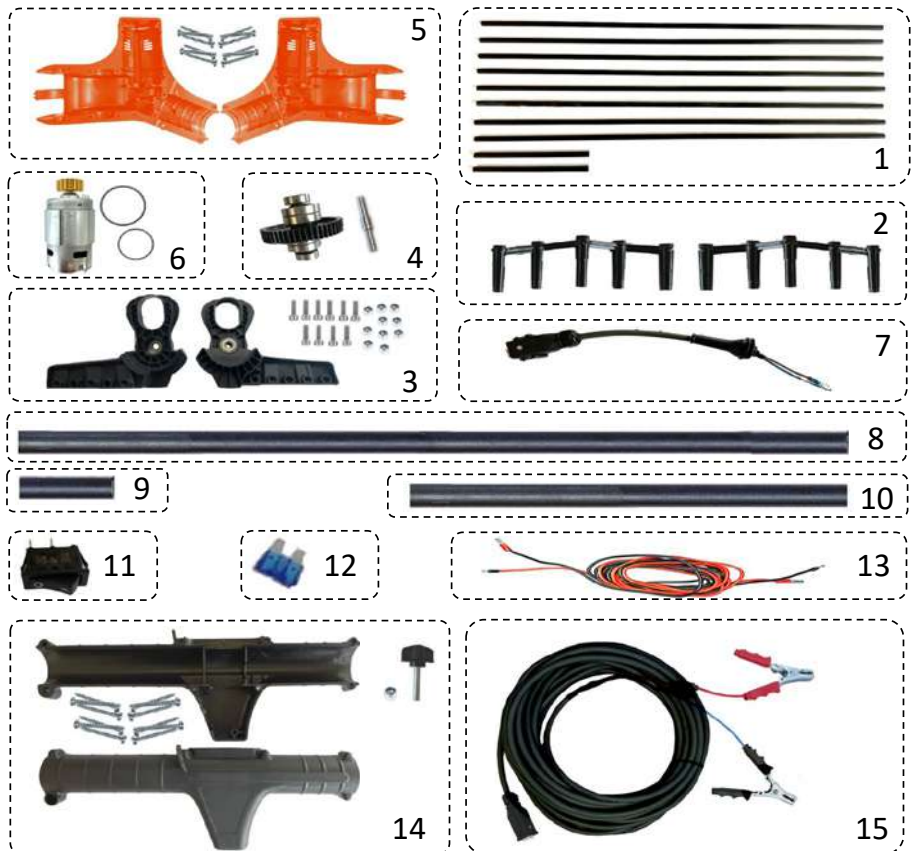

BCL51

Revision: 00

SNA Europe does not cover the causes over negligence in tool use and/or repair, inadequate care, or abnormal usage conditions. Follow the instructions for proper use, safety, maintenance and servicing given by SNA Europe

5042022

Nº	CODE	DESCRIPTION
1	BCL5201	CARBON RODS KIT
2	BCL5202	RODS FRAME KIT
3	BCL5203	COMBS KIT
4	BCL5204	GEAR ASSY
5	BCL5205	HEAD PLASTIC CASE ASSY
6	BCL5206	ENGINE ASSY
7	BCL5207	CONNECTING RODS ASSY
8	BCL5208	MAIN PIPE 1640MM
9	BCL5209	AUX PIPE 150MM
10	BCL5210	EXTENSION PIPE 700MM
11	BCL5211	PCB ASSY
12	BCL5212	INTERNAL WIRING
13	BCL5213	HANDLE CASE ASSY
14	BCL52CNV	12V CONV + 14M EXT CORD ASSY
15	BCL52CNV1	14M EXT CORD + CLAMPS
16	BCL52CNV2	CONVERTER PCB + ALU CASE
17	BCL5B101	BATTERY CABLE



BAHCO

BCL52FP

Revision: 00



SNA Europe does not cover the causes over negligence in tool use and/or repair, inadequate care, or abnormal usage conditions. Follow the instructions for proper use, safety, maintenance and servicing given by SNA Europe

16052022

Nº	CODE	DESCRIPTION
1	BCL5201	CARBON RODS KIT
2	BCL5202	RODS FRAME KIT
3	BCL5203	COMBS KIT
4	BCL5204	GEAR ASSY
5	BCL5205	HEAD PLASTIC CASE ASSY
6	BCL5206	ENGINE ASSY
7	BCL5207	CONNECTING RODS ASSY
8	BCL5208TP	TELESCOPIC PIPE 1640MM
9	BCL5209	AUX PIPE 150MM
11	BCL5211	PCB ASSY
12	BCL5212TP	INTERNAL WIRING
13	BCL5213	HANDLE CASE ASSY
14	BCL52CNV	12V CONV + 14M EXT CORD ASSY
15	BCL5215TP	TIGHTENING CLAMP ASSY
16	BCL52CNV1	14M EXT CORD + CLAMPS
17	BCL52CNV2	CONVERTER PCB + ALU CASE
18	BCL5B101	BATTERY CABLE



BAHCO

BCL52TP

Revision: 00



SNA Europe does not cover the causes over negligence in tool use and/or repair, inadequate care, or abnormal usage conditions. Follow the instructions for proper use, safety, maintenance and servicing given by SNA Europe

16052022



TIJERAS DE PODA DE UNA MANO

Tijera de poda ergonómica de mango fijo



ergo®



PX

	€		
15	58,20	2	PX-S1
20	58,20	2	PX-S2
15	58,20	2	PX-M1
20	58,20	2	PX-M2
20	58,20	2	PX-M2-L
30	58,20	2	PX-M3
20	58,20	2	PX-L2
30	58,20	2	PX-L3

L: Zurdos

Tijera de poda ergonómica de mango rotativo



ergo®



PXR

	€		
20 mm	84,26	2	PXR-S2-L
15	84,26	2	PXR-S1
20	84,26	2	PXR-S2
15	84,26	2	PXR-M1
20	84,26	2	PXR-M2
20	84,26	2	PXR-M2-L
30	84,26	2	PXR-M3
20	84,26	2	PXR-L2

L: Zurdos

Recambio de hoja para tijera de poda



R211P/R300P/R500P/R600P

	€		
Px/ PXR N° 2, P1-20, P2-20	20,66	1	R211P
PX/ PXR N° 2, P1-20, P2-20	19,23	80	R211P-BULK80
Px/ PXR N° 1	20,29	1	R300P
Px/ PXR N° 3, P1-23	20,37	40	R500P
Px-M2-L & PXR-M2-L	20,20	1	R600P

Recambio de contra-hoja para PX/PXR



R303P-R603P

	€		
Px-S1, Px-M1, Px-L1, PXR-M1, PXR-L1	21,66	1	R303P
Px-S2, Px-M2, Px-L2, PXR-M2, PXR-L2, P1-20	21,89	1	R403P
Px-S3, Px-M3, Px-L3, PXR-M3, PXR-L3, P1-23	19,86	1	R503P
Px-M2-L, PXR-M2-L	19,33	1	R603P

Recambio de mangos para tijeras de poda PX/PXR Con muelle

ergo®



R811P-RT825P

	€		
Px-S	26,78	1	R811P
Px-M	25,33	1	R812P
Px-L	25,34	1	R813P
Px-M2-L	26,43	1	R815P
PXR-S	51,42	1	RT821P
PXR-M	49,33	1	RT822P
PXR-L	56,75	6	RT823P
PXR-M2-L	67,29	1	RT824P

Recambio del perno central para tijera de poda ERGO™



R900P

		€		
PX & PXR	20	8,24	1	R900P

Recambio del bloqueo del perno central



R901P

		€		
PX & PXR	10	7,39	30	R901P

Juego de recambio de 4 tornillos para PX/PXR



R902P

		€		
PX & PXR	20	6,64	24	R902P

Recambio de 2 topes de goma para tijeras de poda PX/PXR
50 topes a granel



R903P/R1269P

		€		
PX & PXR, P1 & P2, P64	10	5,42	1	R903P
PX & PXR, P1 & P2, P64	486	1,41	50	R1269P-BULK50

Recambio del cierre para tijeras de poda PX/PXR



R904P

	g	€		
Px & PXR, P1-20 & P1-23	10	7,58	1	R904P

Recambio muelles



R905P-R907P

	g	€		
PX & PXR, P64	10	6,05	1	R905P
PX & PXR, P64	164	2,39	50	R905P-BULK50
PX & PXR	10	6,05	1	R906P
PX & PXR	220	2,53	50	R906P-BULK50
PX & PXR	10	6,28	1	R907P

Dureza: R905P (blanda)
R906P (media)
R907P (dura)

Tijera de poda de una mano, forjada



P3

	€		
20	62,68	2	P3-20-F
25	65,14	2	P3-23-F

Tijera de poda de una mano



P110

	€		
20	31,60	2	P110-20-F
25	35,82	2	P110-23-F

Tijera de poda una mano con mango de composite



P1

	€		
20	43,63	5	P1-20
30	49,09	5	P1-23

Repuestos disponibles

Tijera de poda de una mano



P108

	€		
20	32,77	2	P108-20-F
25	37,46	2	P108-23-F

Tijera de poda de una mano, forjada



P5

	€		
25	73,28	2	P5-23-F

Cizalla de una mano



P138

	€		
20	44,26	6	P138-22-F

Tijeras para recolección de rosas



P64

	€		
12	40,87	12	P64-20-BULK12



Tijera de poda para trabajos de mantenimiento jardín



PG-01-F/PG-03-L

	€			
12-20	32,63	6	PG-01-F	
12-20	33,66	2	PG-03-L	

PG-01-F: Diestros PG-03-L: Zurdos

Tijera de poda de una mano



P121

	€			
15	24,00	6	P121-18-F	
20	25,16	6	P121-20-F	
25	26,34	6	P121-23-F	

Tijera de poda de una mano



P126

	€			
15	18,03	6	P126-19-F	
20	23,18	6	P126-22-F	

Tijera de poda de una mano



PG-12-F

	€			
20	15,51	10	PG-12-F	
20 mm	14,39	15	PG-12-BULK15	

Recambio del yunque de aluminio con remache



R221P/R222P

	€			
P138-22	7,69	1	R221P	
P138-22	5,84	50	R221P-BULK50	

Recambio de hoja para P1 y P2*



R201P/R171P

	€			
P1-22, P2-22	12,82	80	R201P-BULK80	

*versiones anteriores a las actuales

Recambios de hoja con pasador para tijeras de poda una mano y de pértiga



R112PG-R124PG/R224P

	€			
P3-20, P5-20	17,46	1	R112PG	
P108-20, P110-20	17,65	1	R114PG	
P3-23, P5-23	18,54	30	R122PG	
P108-23, P110-23, P34-27A	18,84	30	R124PG	
P138-22	21,02	1	R223P	
P138-22	17,51	80	R223P-BULK80	

Recambio* de contra-hoja para tijeras de poda una mano



R202P/R271P

	€			
P1-22, P2-22	22,20	1	R202P	

*versiones anteriores a las actuales

Perno completo para tijeras de poda de una mano



R239P/R141P/R142P/R157H

	€			
P34-27A, P3-20, P3-23, P5-20, P5-23, P108-20, P108-23, P110-20, P110-23	7,94	24	R142P	
P1-20, P1-22, P2-20, P2-22, P6-20, P7-20	8,76	1	R239P	

Recambios de contra-hoja y pasador
Tijeras de poda de una mano y pértiga



R113PG/R123PG

	€		
P108-20, P110-20	18,84	30	R113PG
P108-23, P110-23	18,65	30	R123PG

Recambio de cierre



R341P/R474P

	€		
P3-20, P3-23	5,20	12	R341P
P5-20, P5-23, P108-20, P108-23, P110-20, P110-23	5,03	1	R474P

Recambio de muelles para tijeras de poda de una mano

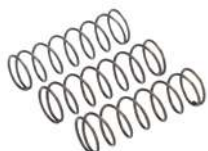

R438P/R463P

	€		
P39-22	4,45	1	R439P
P121-23	7,60	1	R463P
P138-22	6,50	1	R438P
P138-22	2,00	50	R438P-BULK50

Recambio de muelle y tope para tijeras de poda de una mano



R1069P

	€		
P1-20, P1-23, P2-20, P6-20, P7-20	5,46	12	R1069P

Recambio de muelle, tope de goma y tope metálico



R1068

	€		
P3-20, P3-23, P5-20, P5-23, P108-20, P108-23, P110-20, P110-23	6,49	1	R1068

Recambios para P5-20 y P-23



R1080P

	€		
P5-20, P5-23	6,41	1	R1080P

Recambio de tornillos, tuerca y cierre para los mangos



R1601

	€		
P1-20, P1-22, P2-20, P6-20, P7-20	8,55	1	R1601

Sistema de cierre con tornillo y tuerca



R478P/R480P

	€		
P108	9,27	1	R478P
P5	7,50	1	R480P

HERRAMIENTA DE RECOGIDA DE FRUTA

Tijera de vendimia y recolección



P123

	€		
10	11,79	30	P123-19-BULK30

Tijera de vendimia y recolección



P127

	€		
6	11,60	30	P127-19-BULK30



Tijera de vendimia y recolección



P128

	€		
6	15,12	6	P128-19
6	11,91	30	P128-19-BULK30

Tijera de vendimia y recolección de hoja larga.
Cabeza de corte inclinada de 11°



P129

	€		
6	12,93	30	P129-19-BULK30

Recambios de muelles y topes
P123/P127/P128/P129



R1071/R1075

		€		
P123, P127, P128, P129	20	10,96	14	R1071
P123, P127, P128, P129	130	1,10	50	R1075-BULK50

**TIJERAS DE PODA
DE DOS MANOS**

Tijera de poda super ligera



P114-SL

	L	€		
30	400	78,56	2	P114-SL-40
30	500	80,19	2	P114-SL-50
30	600	87,32	2	P114-SL-60

Tijera de poda de dos manos



P16

	L	€		
30	400	78,37	2	P16-40
30	500	94,66	2	P16-50-F
30	600	97,82	2	P16-60-F

Tijera de poda de dos manos



P16-40W

	L	€		
30 mm	400 mm	78,19	2	P16-40W

Tijera de poda super ligera



P116-SL

	L	€		
35	400	90,60	2	P116-SL-40
35	500	94,87	2	P116-SL-50
35	600	97,83	2	P116-SL-60
35	700	100,84	2	P116-SL-70

Tijera de poda super ligera



P160-SL

	L	€		
45	600	105,52	2	P160-SL-60
45	750	111,89	1	P160-SL-75
45	900	119,74	1	P160-SL-90

Tijera de poda de dos manos



P19

	L	€		
50	800	172,76	1	P19-80-F

Tijera de poda de corte deslizante y multiplicador



P280-SL

Icon	L	€	Icon	Icon
	600	69,94	2	P280-SL-60
	800	76,09	2	P280-SL-80

Tijera de poda tipo cizalla con sistema multiplicador



P173-SL

Icon	L	€	Icon	Icon
	850 mm	109,22	1	P173-SL-85

Tijera de poda de dos manos



P130-P140

Icon	L	€	Icon	Icon
	450	37,16	6	P130-F
	600	47,14	6	P140-F

Tijera de poda ligera de dos manos



PG-18

Icon	L	€	Icon	Icon
	450	40,96	2	PG-18-45-F
	610	44,49	2	PG-18-60-F

Tijera de poda de dos manos telescópica



PG-19

Icon	L	€	Icon	Icon
	700 - 900	60,49	2	PG-19-F

Recambio de hoja para tijeras de poda de dos manos



R114V/R373A

Icon	€	Icon	Icon
	20,48	28	R160A-BULK28
	33,95	25	R114V
	23,53	28	R114V-BULK28
	34,04	1	R16V
	23,61	14	R16V-BULK14
	33,86	8	R115V
	27,53	14	R115V-BULK14
	30,62	1	R116V
	26,32	36	R116V-BULK36
	52,89	1	R119V
	26,06	1	R160A
	33,74	25	R373A

Recambio de contra-hoja para tijeras de poda de dos manos



R214V/R26V/R260A/...

Icon	€	Icon	Icon
	28,77	1	R214V
	15,48	28	R214V-BULK28
	27,87	8	R216SL
	28,58	1	R215V
	26,57	1	R214SL
	25,68	16	R260A
	28,63	40	R716VCB
	24,94	1	R680V
	32,67	1	R619V

Recambio de topes de goma para tijeras de poda de dos manos y cortasetos



R430V-R516V

Icon	€	Icon	Icon
	7,88	22	R440V

Recambio de yunque con tornillos para tijeras de poda de dos manos



R372H

Icon	€	Icon	Icon
	20,25	1	R372H
	14,14	1	R376H



Perno central/tuerca para tijeras de poda de dos manos



R312V-R318V/R143PV/R144PV/R146

	€		
P16	7,25	1	R143PV
P16*	7,90	1	R143PVCB
P160	7,31	24	R144PV
P14, P174, P176-75	7,33	24	R146VS
P14, P174, P176-75	4,75	50	R146VS-BULK50
P114-SL, P116-SL	9,80	22	R166V
P172-65 /-85	15,02	1	R312V
P-SL-40 /-45 /-60	13,05	1	R315V
P280-(SL)	6,87	22	R328V
P180-70, P19-80, P172	13,99	1	R318V

Juego completo recambios mango, tornillo y tuerca para tijeras de poda de dos manos



R415V-R773V

	€		
P-SL, P-SL2, P114, P116	10,22	1	R415V
P19-80	10,41	1	R519V
P14, P16	9,66	1	R615V
P160	9,04	24	R660V
P172-SL	6,71	14	R772V
P280-SL-80	6,30	1	R773V

Tornillo hexagonal para ajustar a la hoja al yunque



R272H

	€		
P172-65/-85, P172-SL-85	10,28	1	R272H

SERRUCHOS CON PÉRTIGA Y PODADERAS DE ALTURA



Pértiga telescópica de aluminio



ATP-200

	€		
2000-3520	99,49	1	ATP-200-350
2070-5040	115,89	1	ATP-200-500

Pértigas telescópicas



AP-/FP-

	€		
2000 - 5000	81,94	1	AP-5M
2000 - 3500	62,04	1	AP-3M
1800 - 3200	101,92	1	FP-3M

Sistemas de bloqueo para pértigas telescópicas

RCAM30/RCAM36

	€		
ATP-200-350/500	4,47	1	RCAM30
ATP-200-500 & AP-5M	4,47	1	RCAM36

Pértiga telescópica corta de aluminio



ATP-110-210

	€		
1100 - 2100 mm	78,19	1	ATP-110-210

Pértiga base de aluminio



ASP-1850G

	€		
1870 mm	52,75	1	ASP-1850G

Extensión de aluminio para pértiga



ASP-1850

	€		
1870 mm	43,44	1	ASP-1850

Adaptador para hojas de serruchos AS



ASP-AS

	€		
135 mm	18,76	4	ASP-AS

Adaptador para podaderas de altura P34-37 y P34-27A-F



ASP-ATP

	g	€		
160 mm	100	28,54	4	ASP-ATP

Adaptador para serruchos ASP-AS en pértigas tradicionales AP-3M, AP-5M & FP-3M



RAUNI

		€		
ATP-110-210	82	18,49	6	RAUNI

Gancho para pértiga con adaptador válido para pértigas ASP y pértiga ATP-110-210



ASP-AS-HOOK

	€		
325	40,95	4	ASP-AS-HOOK

Podadera de pértiga, triple efecto multiplicador



P34-37

	€		
40	70,23	2	P34-37

Podadera de pértiga, Doble efecto multiplicador



P34-27A

	€		
30	37,46	2	P34-27A-F

Podadera con pértiga



AP-234

		€		
30	2200	95,57	2	AP-234-F

Repuestos para podadera con pértiga AP-234

DESCRIPCIÓN	€		
contrahoja	13,21	1	R133PG
muelle	9,61	1	R427AE

Podadera de altura con pértiga telescópica y cabeza de corte giratoria



ATP-230-410

		€		
32 mm	2370 - 4110 mm	111,20	2	ATP-230-410

*Pedido mínimo 2 unidades

Repuestos para pértiga ATP-230-410

DESCRIPCIÓN	€		
Muelle pértiga	7,36	1	R4230
Hoja & Perno	24,70	1	R230P
Multiplicador	25,98	1	RPL230G
Cuerda Dyneema	13,57	1	RD1M
Cuerda interior	25,32	1	RD7M
Tirador inferior	10,90	1	RBCP230

Recambio de hoja de corte para podadera de pértiga



R137E

	€		
P34-37	21,34	30	R137E

Serrucho curvo con dentado japonés, para pértigas ASP. Corte fino



ASP-AS-C-F

		€		
330	7	63,94	5	ASP-AS-C33-JT-F

Serrucho curvo con dentado japonés, para pértigas ASP. Corte medio



ASP-AS-C-M

		€		
360	6,2	66,68	5	ASP-AS-C36-JT-M



Serrucho curvo con dentado japonés, para pértigas ASP. Corte grueso



ASP-AS-C-C

			€		
390		5,4	73,22	5	ASP-AS-C39-JT-C
450		5,4	75,84	2	ASP-AS-C45-JT-C

Serrucho de poda



339-/340-

		T/''	€		
360		6	18,16	4	339-6T
360		6	19,37	4	340-6T

Serrucho de poda
Para pértiga telescópica de Ø 25 mm



383-/384-

		T/''	€		
360		6	20,58	4	383-6T
360		6	19,37	4	384-6T
360		6	19,37	4	384-5T

Serrucho de poda, para pértiga telescópica de Ø 25 mm



385-/386-

		g	€		
360		410	20,58	4	385-6T
360		410	21,78	4	386-6T

Leva y tornillo para ATP-200-350/500



RCAM

		g	€		
ATP-200-350 ; ATP-200-500 ; ATP-110-210		29	4,47	20	RCAM30
ATP-200-500 ; ATP-110-210		37	4,47	20	RCAM36

Recambio de perno central y tuerca para podadera de altura P34-37



R142P/R337E

		€		
P34-37		10,69	1	R337E

Recambio de contra-hoja para podaderas de una mano y de pértiga
Para podaderas manuales y de altura



R133PG

		€		
P34-27A		13,21	1	R133PG

Recambio de muelle para podadera de pértiga



R427AE/R427E/R437E

		€		
P134, P34-27A		9,61	18	R427AE
P34-37		10,69	18	R437E

CORTASETOS

Cortasetos profesional



P51

		€		
570	25	53,26	2	P51-F

Cortasetos



P51-SL

		€		
570	25	53,26	2	P51-SL

Cortasetos mangos largos



P51H-SL

		€		
730	1076	56,19	2	P51H-SL

Cortasetos ligero, mango largo



P54H-SL

		€		
650	22.5	110,01	2	P54H-SL-25

Cortasetos telescópico



PG-57-F

		€		
800-1050 mm	20	44,49	2	PG-57-F

Cortasetos con mango de madera



P57-25

		€		
540	23	40,96	4	P57-25-F

Cortasetos ligero de precisión para arte topiario



P52-SL-20

		€		
590 mm	18	91,26	2	P52-SL-20

Cortasetos



P59

		€		
580*	21	34,17	6	P59-25-F

*Recambios no disponibles

Cortasetos ligero, corto



P54-SL

		€		
550	22.5	110,02	2	P54-SL-25

Cortasetos ligero



PG-56

		€		
540	23	42,14	2	PG-56-F

Recambios de topes de goma para cortasetos



R440V-R516V

	€		
P14, P16, P180-70, P19-80, P160-60, P51	5,45	22	R515VS
P160, P160-SL, P280-SL	4,58	22	R516V
P53-SL, P54H-SL, P52-SL-20	6,12	22	R444V



Perno central/tuerca para cortasetos



R146VC/R147V

	€			
P51, P51H, P52, P53, P54, P52-SL-20	8,47	22	R146VC	
P55, P57	7,32	24	R147V	

CORTACÉSPEDES

Cortacésped regulable en tres posiciones



GS-76

L	g	€		
355	435	21,61	8	GS-76

Cortacésped regulable de 9 posiciones (180°)



GS-180

L	€		
375	29,48	6	GS-180-F

Cortacésped



P74

L	g	€		
1100	2000	63,48	1	P74

Cortacésped



P75

L	g	€		
1000	1900	62,35	1	P75

NAVAJAS DE PODA

Navaja para injertar



P11

L	g	€		
180	70	39,35	6	P11

Navaja para injertar



P20

L	g	€		
190	100	46,70	6	P20

Navaja multi-uso



K-AP-1

L	€		
175	31,44	10	K-AP-1

Navaja multi-uso



K-GP-1

L	€		
170	34,46	10	K-GP-1

TIJERAS

Tijera tamaño pequeño



FS-5

L	€		
125	16,80	10	FS-5

Tijera tamaño medio



FS-8

	€		
165	22,87	10	FS-8

Tijera tamaño grande



FS-7.5

	€		
200	28,21	10	FS-7.5

ARCOS TRONZADORES

Arco tronizador para madera verde y seca
23: Madera verde//51: Madera seca



10

		€		
530	21	15,95	5	10-21-51
607	24	17,14	5	10-24-23
607	24	17,13	5	10-24-51
759	30	19,37	5	10-30-23
759	30	20,85	5	10-30-51

Arco tronizador



332

		€		
530	21	18,89	5	332-21-51

Arco tronizador profesional
Tipos de hoja 23 o 51



SE -15-16

		€		
530	21	8,79	5	SE-16-21
530	21	7,59	5	SE-16-21-23
607	24	8,63	5	SE-15-24
759	30	9,17	5	SE-15-30
759	30	9,25	5	SE-15-30-23
810	32	10,11	5	SE-15-32
912	36	10,76	5	SE-15-36
912	36	10,71	5	SE-15-36-23

Arco tronizador manejable de 15" madera verde



331-15

		€		
378	15	14,91	5	331-15-23

Arco tronizador con hoja posicionable



2-21-51

		€		
530	21	16,84	5	2-21-51

Arco tronizador



331-21

		€		
530	21	15,95	5	331-21-51-KP

Arco tronizador con hoja posicionable



333

		€		
350	14	30,33	5	333



Arco tronzador para tubos de ventilación



14-24

Modelo	Longitud (cm)	Peso (g)	Precio (€)	Paquetes	Referencia
607	24	21,92	5	14-24-3810	

Arco de sierra multiuso - madera y metal



9-12

Modelo	Longitud (cm)	Peso (g)	Precio (€)	Paquetes	Referencia
320	12	19,08	5	9-12-51/3806-KP	

Hoja de arco tronzador - madera seca



51

Modelo	Longitud (cm)	Peso (g)	Precio (€)	Paquetes	Referencia
320	12	3,69	10	51-12	
530	21	4,97	10	51-21	
607	24	5,31	10	51-24	
759	30	5,95	10	51-30	
810	32	6,18	10	51-32	
912	36	6,42	10	51-36	

Hoja de arco tronzador - madera verde



23

Modelo	Longitud (cm)	Peso (g)	Precio (€)	Paquetes	Referencia
378	15	2,81	10	23-15	
530	21	4,97	10	23-21	
607	24	5,31	10	23-24	
759	30	5,95	10	23-30	
810	32	6,18	10	23-32	
912	36	6,57	10	23-36	

Hoja para arco tronzador: madera verde para arco 333



333-5

Modelo	Longitud (cm)	Peso (g)	Precio (€)	Paquetes	Referencia
350	14	7,51	10	333-5	

SERRUCHOS DE PODA



Serrucho de poda



349

Modelo	Longitud (cm)	Peso (g)	Precio (€)	Paquetes	Referencia
300	7	186,70	4	349	

Serrucho de poda plegable



PG-72

Modelo	Longitud (cm)	Peso (g)	Precio (€)	Paquetes	Referencia
190	7	18,33	4	PG-72	

Serrucho plegable, dentado XT, recubrimiento especial



396-LAP

Modelo	Longitud (cm)	Peso (g)	Precio (€)	Paquetes	Referencia
190	200	39,59	10	396-LAP	
190	44	16,36	100	396-BLADE	

Serrucho de poda plegable, dentado JS



396-JS

Modelo	Longitud (cm)	Peso (g)	Precio (€)	Paquetes	Referencia
190	5	24,21	4	396-JS	

Serrucho de poda plegable, dentado JT



396-JT

Modelo	Longitud (cm)	Peso (g)	Precio (€)	Paquetes	Referencia
190	7	24,21	4	396-JT	

Serrucho de poda plegable, dentado XT



396-HP

Modelo	Longitud (cm)	Peso (g)	Precio (€)	Paquetes	Referencia
190	7	20,58	4	396-HP	

Serrucho de poda con mango de madera



4211-/4212-



			€		
280	7	7	18,16	4	4211-11-6T
360	7	7	20,58	4	4211-14-6T
280	7	7	18,16	4	4212-11-6T
360	7	7	20,58	4	4212-14-6T

Serrucho de poda con funda



51 -JS



			€		
240	5	5	23,50	4	5124-JS-H
280	5	5	28,21	4	5128-JS-H

Serrucho de poda, dentado JT



41 -JT



			€		
240	7	7	24,21	4	4124-JT-H
280	7	7	29,06	4	4128-JT-H

Juego de serrucho plegable 396-LAP y cuchillo - machete 2444-LAP



LAP-KNIFE

			€		
329	g		42,75	10	LAP-KNIFE

Hojas de recambio para serrucho de poda 51-JS



5724-JS/5728-JS

			€		
240	5	5	16,45	1	5724-JS
280	5	5	19,75	1	5728-JS

Hojas de recambio para serrucho de poda 41-JT



4724-JT/4728-JT

			€		
240	7	7	18,16	1	4724-JT
280	7	7	18,76	1	4728-JT

Hojas de recambio para serrucho 396-JS



396-JS-BLADE

			€		
190	5	5	21,78	1	396-JS-BLADE

Hojas de recambio para serrucho 396-JT



396-JT-BLADE

			€		
190	7	7	21,78	1	396-JT-BLADE

Hoja de recambio para serrucho 396-HP



396-HP-BLADE

			€		
190	7	7	13,31	1	396-HP-BLADE

Hojas de recambio, serrucho/poda 4211, 4212, 339 y 340 y podaderas/pértiga P34-37



4400-/4420-

		T''	€		
280	6	6	11,79	10	4400-11
360	6	6	13,31	10	4400-14
280	6	6	11,79	10	4420-11
360	6	6	13,31	10	4420-14
280	6	6	10,29	10	4400-11-BULK
360	6	6	11,49	10	4400-14-BULK
280	6	6	10,29	10	4420-11-BULK
360	6	6	11,49	10	4420-14-BULK

BULK: sin embalaje en blíster y sin protector de hoja



REPUESTOS Y ACCESORIOS

Hoja curva de repuesto serrucho para pértiga, corte fino



AS-F-BLADE

		€		
330	7	33,90	15	AS-C33-JT-F

Hoja curva de repuesto serrucho para pértiga, corte medio



AS-M-BLADE

		€		
360	6,2	36,32	15	AS-C36-JT-M

Hoja curva de repuesto serrucho para pértiga, corte grueso



AS-C-C-BLADE

		€		
390	5,4	36,32	15	AS-C39-JT-C
450	5,4	42,36	15	AS-C45-JT-C

ACCESORIOS Y MANTENIMIENTO

Piedra sintética para afilado, 2 granos 180/400



LS-COMBINESS

	€		
100	13,33	1	LS-COMBINESS

Piedra sintética para afilado, grano 320



LS-CORINDON

	€		
100	15,89	1	LS-PIERRE CORINDON

Afilador profesional de carburo



SHARP-X

	€		
100	23,95	10	SHARP-X
100	718,21	1	SHARP-X-DISP

Piedra sintética para afilado, grano 180



LS-PIERRE-FAUX

	€		
230	16,88	1	LS-PIERRE-FAUX

Piedra sintética, tipo "Carbor", para afilado, grano 220
Tipo "Carbor", grano 220



LS-6160-23

	€		
230	9,21	1	LS-6160-23

Lubricante 50 ml



LUB-2015

	€		
60	20,56	6	LUB-2015

Funda de cuero



PROF-H

g	€		
86	25,58	2	PROF-H

Funda para podadera de dos manos



PROF-LOPP

g	€		
390	34,59	1	PROF-LOPP

Funda para podadera



PROF-SEC

g	€		
150	21,65	1	PROF-SEC

HACHAS Y MAZAS



Hachas con mango de madera



HUS

	g	€		
380	830	34,54	4	HUS-0.6-380
500	1030	38,62	4	HUS-0.8-500

Hacha tipo Alemán



HGPS

	g	€		
380	944	33,94	4	HGPS-0.8-380-WB
400	1130	35,79	4	HGPS-1.0-400-WB
360	810	23,97	10	HGPS-0.6-360
380	930	29,30	4	HGPS-0.8-380
400	1180	32,78	4	HGPS-1.0-400

Hachas con mango de madera



HUS-1.0-650

	g	€		
650	1610	43,47	4	HUS-1.0-650

Hacha con mango en fibra de vidrio



HFGPS

	g	€		
380	1010	46,85	4	HFGPS-0,7-400FG

Hacha tipo Alemán



FGS-810

	g	€		
800	2230	56,74	4	FGS-1.6-810
800	2480	61,74	4	FGS-1.8-810

Hacha tipo Canadiense, mango de nogal



FCP

	g	€		
800	2540	84,34	4	FCP-1.8-810
850	3000	93,82	2	FCP-2.3-860

Hacha tipo Alemán



FGS

	g	€		
700	1730	53,23	4	FGS-1.25-700-WB
600	1330	47,78	4	FGS-1.0-600
700	1850	50,36	4	FGS-1.25-700

Hacha con mango en fibra de vidrio



FFSS

	g	€		
900	2400	70,03	4	FFSS-1.5-900FG



Hacha



SUS

Icono	g	€	Icono	Icono
	2660	86,02		
800			4	SUS-2.0-800

Hacha tipo Canadiense, Mango de nogal



MCP

Icono	g	€	Icono	Icono
	3300	75,60		
800			2	MCP-2.5-810

Maza con mango en fibra de vidrio



LS-MASSE

Icono	g	€	Icono	Icono
	4800	59,18		
900			2	LS-MASSE-4FG
900	4450	47,94	2	LS-MASSE-4

Maza con mango en fibra de vidrio



LS-MASSE-TR

Icono	g	€	Icono	Icono
	4840	65,08		
900			2	LS-MASSE-TR-4FG

Mango de repuesto para hachas



SH

Icono	L	€	Icono	Icono
800		27,87	1	SH-FCS-810
900		32,00	1	SH-FCS-860
600		22,08	1	SH-FGS-600
700		24,10	12	SH-FGS-700
800		28,71	1	SH-FGS-800
900		20,83	1	SH-FGS-1.8-810
375		19,91	1	SH-HGFS-400FG
400		17,66	1	SH-HGFS-400
900		21,52	12	SH-MES-F-900
360		14,92	12	SH-HGFS-360
380		16,01	1	SH-HGFS-380
380		16,01	1	SH-HUS-380
500		21,00	1	SH-HUS-500
650		23,74	1	SH-HUS-650
900		27,62	12	SH-MES-900
915		41,35	12	SH-MES-900FG
800		28,71	12	SH-SUS-800
800		28,71	1	SH-MCS-800
905		34,64	1	SH-FCP-860

FB: Fibra Vidrio

Hacha



LS/MES

Icono	g	€	Icono	Icono
900	3270	50,79	2	LS-MERLIN-2.5
900	3330	65,56	2	LS-MERLIN-2.5FG
900	3620	55,39	2	MES-3.0-900

FG: Fibra de vidrio

Hacha rompedora



MES

Icono	g	€	Icono	Icono
900	3880	61,78	2	MES-3.5-900
900	4310	79,39	2	MES-3.5-900FG

Pico de hacha



PAGES-2.0-900FG

Icono	g	€	Icono	Icono
	3000	77,22		
900			1	PAGES-2.0-900FG

Cabeza para pico



PAGES

Icono	g	€	Icono	Icono
	2000	32,13		
450			1	PAGES-2.0

Mangos de repuesto para pico de hacha



SH-PAGES

Icono	g	€	Icono	Icono
900	690	21,19	1	SH-PAGES-900
920	1030	49,02	1	SH-PAGES-900FG

CUÑAS

Cuñas de Tumba



LS-COIN

Length (cm)	Weight (g)	Price (€)	Quantity	Model
260	295	32,43	2	LS-COIN 26 CM
190	170	30,19	4	LS-COIN 19 CM

Cuñas rompedoras



WT

Length (cm)	Weight (g)	Price (€)	Quantity	Model
220	2000	59,68	4	W-T-2.0

Cuñas rompedoras



WS

Length (cm)	Weight (g)	Price (€)	Quantity	Model
230	1500	20,73	4	W-S-1.5
250	2000	26,42	4	W-S-2.0
260	2500	32,78	4	W-S-2.5

PEQUEÑAS HERRAMIENTAS DE JARDINERÍA



Azada



P262

Length (cm)	Price (€)	Quantity	Model
315	16,81	10	P262

Azuela



P272

Length (cm)	Price (€)	Quantity	Model
450	21,50	5	P272

Lanza Azuela



P268

Length (cm)	Price (€)	Quantity	Model
320	17,42	10	P268

Lanza azuela



P278

Length (cm)	Price (€)	Quantity	Model
455	21,79	5	P278

Azada horquilla



P267

Length (cm)	Price (€)	Quantity	Model
320	17,42	10	P267

Cultivador



P274

Length (cm)	Price (€)	Quantity	Model
470	20,89	5	P274

Escarvador



P269

Length (cm)	Price (€)	Quantity	Model
315	13,68	10	P269

Plantador de bulbos



P241

Weight (g)	Price (€)	Quantity	Model
340	13,06	5	P241



PODADERA NEUMÁTICA



Podadera neumática



9210

		€		
30	28	14,41	1	9210-20

Hoja para podadera neumática



9210-1

		€		
9210	82	55,86	1	9210-1

Cabeza cortante para podadera neumática



9210-10

		€		
9210	212	104,84	1	9210-10

Anillos para las juntas



9210-20

		€		
9210	28	14,41	1	9210-20

Casquillos de latón



9210-1720100

		€		
9210	55.3	11,47	1	9210-1720100

Sello para pistón



9210-1230235

		€		
9210	6.7	8,09	1	9210-1230235

Pistón



9210-1690148

		€		
9210	22	19,86	1	9210-1690148

Amortiguadores



9210-1730107

		€		
9210	176	13,81	10	9210-1730107

Muelles de retorno



9210-1640142

		€		
9210	26.6	8,70	1	9210-1640142

Varilla de acoplamiento



9210-1700118

		€		
9210	41	42,07	1	9210-1700118

Remache



9210-1770106

		€		
9210	1000	5,79	10	9210-1770106

Junta de protección del polvo



9210-1230219

		€		
9210	8.6	6,98	20	9210-1230219

Tornillos autorroscantes o de chapa



9210-1060238

		€		
9210	10	0,48	20	9210-1060238

Cubierta frontal



9210-1830137

		€		
9210	9.5	9,22	1	9210-1830137

Cuerpo de podadera



9210-1710266

		€		
9210	193	68,75	1	9210-1710266

Tornillo TCCE



9210-1060177

		€		
9210	7	0,93	1	9210-1060177

Protector de mano



9210-1320281

		€		
9210	35	9,30	10	9210-1320281

**TIJERAS DE PODA ELÉCTRICAS,
MOTOSIERRAS Y ACCESORIOS**

Tijera de poda a batería inalámbrica de 26 mm



BCL226

Ah		
2,5 Ah	201,30	1 BCL226

Hoja para tijeras de poda inalámbricas BCL226



BCL22604

		€		
4 x 25 x 72 mm	0.0274 kg	15,45	1	BCL22604

Contrahoja para tijeras de poda inalámbricas BCL226



BCL22605

		€		
5 x 31 x 80 mm	0.0398 kg	15,45	1	BCL22605

Kit perno central para BCL226



BCL23503

€		
10,45	1	BCL23503



Batería de litio compacta de 27 Wh para BCL226



BCL226B

V			
14,4	2,5Ah	24,75	1 BCL226B

Hoja para tijeras de poda inalámbricas BCL235



BCL23504

		€		
4 x 25 x 72 mm	0,0274 kg	31,00	1	BCL23504

Batería compacta de litio para tijera BCL235 y BCL201B



BCL1B03IB

V			
14,4 V	2,5 A-h	42,90	1 BCL1B03IB

Cargador de baterías BCL226B para tijera BCL226



BCL226C

V_{in}	V_{out}	€		
240 V	16.8 V	31,00	1	BCL226C

Contrahoja para tijera inalámbrica BCL235



BCL23505

		€		
5x31x80	0,0398	16,50		BCL23505

Cargador de batería de tijera BCL235



BCL1C4IB

		€		
1,42 A	120x80x60 mm	33,00	1	BCL1C4IB

Tijera de poda a batería inalámbrica de 35 mm



BCL235

Ah		
2,5 Ah	302,50	1 BCL235

Perno para tijera inalámbrica BCL235



BCL23503

€		
10,45		BCL23503

Bolsa para batería BCLB03IB



BCL20BP

		€		
73x50x115	0,038	5,50		BCL20BP

Tijeras de poda a batería
inalámbricas de 40 mm



BCL240

Ah



2,5 Ah 464,50 1 BCL240

Hoja para tijeras de poda BCL240



BCL24004



6 x 42 x 91 mm 0.062 kg 34,00 1 BCL24004

Contrahoja para tijeras de poda BCL240



BCL24005



6 x 47 x 101 mm 0.08 kg 19,45 1 BCL24005

Kit perno central para BCL240



BCL24013



10,45 BCL24013

Cargador de baterías para BCLIB06IB
de tijeras BCL240



BCL1C5IB

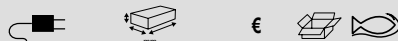

0.95 A 95x53x35 mm 62,25 1 BCL1C5IB

Batería compacta de litio para BCL240



BCL1B06IB

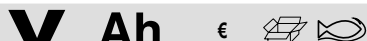

21,6V 2,5Ah 62,99 1 BCL1B06IB

Funda para batería
BCL1B06IB



BCL25BP



86x56x125 0,042 5,50 BCL25BP

Pértiga telescópica para BCL240



BCL25TP



1,5-2,2 mm 202,30 1 BCL25TP

Kit protector de batería



BCL25TP02



12,50 BCL25TP02

Kit de bloqueo de barra



BCL25TP07



10,50 BCL25TP07



Motosierra eléctrica a batería
(Incluye 3 baterías de 4,2 AH)



BCL15IB

	W			€		
110 mm	600 W	1/4 in	38X in	464,30	1	BCL15IB

Tapa para bote de aceite



BCL1516

		€		
		3,00	1	BCL1516

Funda para motosierra BCL15IB



BCL15HOL

€		
10,50	1	BCL15HOL

Protector de cadena



BCL1501

€		
3,70	1	BCL1501

Cable de conexión de motosierra BCL15IB a la batería de la tijera BCL24



BCL15CB

	€		
130 cm	71,00	1	BCL15CB

Tijera de poda a batería 35mm con cable



BCL23

W Ah		€		
1296 3,4 35mm		514,75	1	BCL23

*Incluye batería BCL2B1, cargador BCL2C1, funda BCL2HOL, cinturón BCL2BE, brazaletes BCLAB, grasa BCL2GR y herramientas.

Guía para motosierras BCL15IB



BCL1502

	€		
110 mm	24,75	1	BCL1502

Batería compacta de litio para BCL15IB

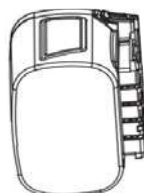

BCL1B08IB

V Wh	€		
21,6 V 91 Wh	99,00	1	BCL1B08IB

Hoja de repuesto para tijera BCL23



BCL2304

	€		
BCL23	38,20	1	BCL2304

Cadena para motosierras BCL15IB



BCL1503

	€		
1,4"	37,10	1	BCL1503

Cargador para baterías BCL1B06IB (tijera BCL240) Y BCL1B08IB (motosierra BCL15IB)



BCL1C5IB

		€		
0.95 A	95x53x35 mm	62,25	1	BCL1C5IB

Contrahoja de repuesto para tijera BCL23



BCL2305

	€		
BCL23	26,90	1	BCL2305

Perno y tuerca centrales y tuerca de bloqueo para las tijeras de poda BCL23



BCL2313

23 x 23 x 55 mm	0.41 kg	17,85	1	BCL2313

Batería para tijera BCL23



BCL2B1

43,2	385,00	1	BCL2B1

Clip de sujeción para batería BCL2B1 (tijera BCL23)



BCL2317

1,70		BCL2317

Cable de conexión de tijera BCL23 para batería BCL2B1



BCL2318

59,45		BCL2318

Cargador para baterías BCL2B1 y BCL2B2 de las tijeras BCL23 y BCL24



BCL2C1

1,66 A	1220x1020x35 mm	70,75	1	BCL2C1

Cable cargador enchufe UEEMC



BBBCAB-EU

6,75		BBBCAB-EU

Cinturón para BCL23



BCL2BE

200x50x35 mm	10,50	1	BCL2BE

Brazalete para BCL23 y BCL24



BCLAB

160x470x10 mm	8,40	1	BCLAB

Tijera de poda a batería de 45mm con cable



BCL24

W Ah					
1512	6,8	45mm	750,00	1	BCL24

*Incluye batería BCL2B2, cargador BCL2C1, funda BCL2HOL, arnés BCL20H, brazaletes BCLAB, grasa BCL2GR y herramientas.

Hoja de repuesto para tijera BCL24



BCL2404

91x42x6 mm	42,20	1	BCL2404

Contrahoja de repuesto para tijera BCL24



BCL2405

BCL24	29,75	1	BCL2405

Perno y tuerca centrales y tuerca de bloqueo para las tijeras de poda BCL24



BCL2413

23 x 23 x 55 mm	0.41 kg	17,85	1	BCL2413

• Los productos incluidos en los capítulos "Tijeras de poda eléctricas, motosierras, vareadores y accesorios" están sujetos a condiciones comerciales especiales.



Clip de sujeción para batería
BCL2B2 (tijera BCL24)



BCL2417

€  
1,70 BCL2417

Batería para tijera BCL24







BCL2B2

V €  
43,2 562,00 1 BCL2B2

Funda para tijeras eléctricas BCL226,
BCL235, BCL240, BCL23 Y BCL24



BCL2HOL

  €  
360x140x40 mm 225g 7,65 1 BCL2HOL

Grasa de litio para tijeras de poda eléctricas







BCL2LGRE

  €  
400ml 80x80x20 mm 14,10 12 BCL2LGRE

Arnes para batería BCL2B2 de la tijera eléctrica
BCL24



BCL20H

  €  
350x225x 35 mm 465 g 24,40 1 BCL20H

VAREADORES Y ACCESORIOS

Vareador fijo 12V 2300mm
más prolongador de 1m



BCL51

W V  €  
370 12 10 477,50 1 BCL51

*Incluye cable para conectar a batería
*Se suministra en pack de 2 unidades

Set 10 varillas de carbono para BCL51

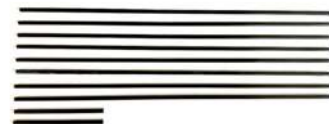



BCL5101

€  
67,95 1 BCL5101

Trama vareador BCL51





BCL5102

€  
21,60 1 BCL5102

Cable de 14 mts. para batería 12 voltios



BCL5115

V  €  
12 14 m 108,10 1 BCL5115

Vareador fijo 36V 2500mm
más extensión de 700mm



BCL52FP

W V  €  
370 36 V 10 758,65 1 BCL52FP

Vareador telescópico
36V 2160mm a 2960mm



BCL52TP

W	V		€		
370	36 V	10	819,35	1	BCL52TP

Set 10 Varillas de carbono para vareador BCL52

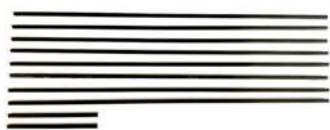

BCL5201

€		
67,95	1	BCL5101

Trama para vareador BCL52



BCL5202

€		
21,60	1	BCL5102

Cable convertidor de 12V a 36V



BCL52CNV

V_{in}	V_{out}		€		
12 V	36 V	14 mm	160,65	1	BCL52CNV

Batería de litio 36 voltios



BCL5B1

Wh	V	€		
720	36	617,55	1	BCL5B1

Cable conexión batería de litio



BCL5B101

	€		
120 m	92,65	1	BCL5B101

Batería de litio 36 voltios con Arnés, cargador y cable



BCL5B1PACK

Wh	V	€		
720	36	926,35	1	BCL5B1PACK

Cargador de baterías vareador



BCL5C1

V_{in}	€		
220	64,85	1	BCL5C1

Arnés para batería BCL5B1



BCL5H

172,95	1 BCL5H

*No incluye batería

Cargador automático de 6A para batería de 12 voltios



BBCE12-6

V	A	€		
12	6	122,97	1	BBCE12-6





10-21-51	7311518229344	15,95	41
10-24-23	7311518229368	17,14	41
10-24-51	7311518229351	17,13	41
10-30-23	7311518229382	19,37	41
10-30-51	7311518229375	20,85	41
14-24-3810	7311518002879	21,92	42
2-21-51	7315962500011	16,84	41
23-15	7311518274665	2,81	42
23-21	7311518012274	4,97	42
23-24	7311518003852	5,31	42
23-30	7311518003869	5,95	42
23-32	7311518003876	6,18	42
23-36	7311518003883	6,57	42
331-15-23	7311518274658	14,91	41
331-21-51-KP	7311518003814	15,95	41
332-21-51	7311518229337	18,89	41
333	7311518005832	30,33	41
333-5	7311518005849	7,51	42
339-6T	7311518128371	18,16	38
340-6T	7311518002008	19,37	38
349	7311518018924	186,70	42
383-6T	7311518128876	20,58	38
384-5T	7311518159795	19,37	38
384-6T	7311518002039	19,37	38
385-6T	7311518002053	20,58	38
386-6T	7311518152017	21,78	38
396-BLADE	7311518299057	16,36	42
396-HP	7311518152284	20,58	42
396-HP-BLADE	7311518156404	13,31	43
396-JS	7311518223250	24,21	42
396-JS-BLADE	7311518223267	21,78	43
396-JT	7311518168056	24,21	42
396-JT-BLADE	7311518168063	21,78	43
396-LAP	7311518172367	39,59	42
4124-JT-H	7311518267803	24,21	43
4128-JT-H	7311518267810	29,06	43
4211-11-6T	7311518152000	18,16	43
4211-14-6T	7311518128883	20,58	43
4212-11-6T	7311518002060	18,16	43
4212-14-6T	7311518002077	20,58	43
4400-11	7311518200596	11,79	43
4400-11-BULK	7311518200633	10,29	43
4400-14	7311518200602	13,31	43
4400-14-BULK	7311518200640	11,49	43
4420-11	7311518200619	11,79	43
4420-11-BULK	7311518200657	10,29	43
4420-14	7311518200626	13,31	43
4420-14-BULK	7311518200664	11,49	43
4724-JT	7311518265847	18,16	43
4728-JT	7311518265854	18,76	43
51-12	7311518044565	3,69	42
51-21	7311518003906	4,97	42
51-24	7311518003913	5,31	42
5124-JS-H	7311518219352	23,50	43
5128-JS-H	7311518219369	28,21	43
51-30	7311518003920	5,95	42
51-32	7311518003937	6,18	42
51-36	7311518003944	6,42	42
5724-JS	7311518216085	16,45	43
5728-JS	7311518216092	19,75	43
9-12-51/3806-KP	7311518044558	19,08	42
9210	7311518278182	257,42	48
9210-1	7311518278212	55,86	48
9210-10	7311518278229	104,84	48
9210-1060177	7311518295424	0,93	49
9210-1060238	7311518295394	0,48	49
9210-1230219	7311518295387	6,98	49
9210-1230235	7311518295325	8,09	49
9210-1320281	7311518295431	9,30	49
9210-1640142	7311518295356	8,70	48
9210-1690148	7311518295332	19,86	48
9210-1700118	7311518295363	42,07	48
9210-1710266	7311518295417	68,75	49
9210-1720100	7311518295295	11,47	48
9210-1730107	7311518295349	13,81	48
9210-1770106	7311518295370	5,79	48
9210-1830137	7311518295400	9,22	49
9210-20	7311518278236	14,41	48
AP-234-F	7311518289027	95,57	37
AP-3M	7311518152062	62,04	36



AP-5M	7311518152079	81,94	36
AS-C33-JT-F	7314150341672	33,90	44
AS-C36-JT-M	7311518337490	36,32	44
AS-C39-JT-C	7314150341542	36,32	44
AS-C45-JT-C	7314150341559	42,36	44
ASP-1850	7311518337124	43,44	36
ASP-1850G	7311518337131	52,75	36
ASP-AS	7311518337377	18,76	36
ASP-AS-C33-JT-F	7314150341665	63,94	37
ASP-AS-C36-JT-M	7314150340590	66,68	37
ASP-AS-C39-JT-C	7314150341535	73,22	38
ASP-AS-C45-JT-C	7314150341566	75,84	38
ASP-AS-HOOK	7311518337582	40,95	37
ASP-ATP	7311518337384	28,54	36
ATP-110-210	7311518337575	78,19	36
ATP-200-350	7311518347062	99,49	36
ATP-200-500	7311518347055	115,89	36
ATP-230-410	7311518337599	111,20	37
BBBCAB-EU	7314150186648	6,75	53
BBCE12-6	7314150330256	122,97	55
BCL1501	7314150520756	3,70	52
BCL1502	7314150520770	24,75	52
BCL1503	7314150520794	37,10	52
BCL1516	7314150521050	3,00	52
BCL15CB	7314150517480	71,00	52
BCL15HOL	7314150523917	10,50	52
BCL15IB	7314150517503	464,30	52
BCL1B03IB	7314150450978	42,90	50
BCL1B06IB	7314150497522	62,70	51
BCL1B08IB	7314150521159	99,00	52
BCL1C4IB	7314150450961	33,00	50
BCL1C5IB	7314150497515	62,25	51
BCL20BP	7314150504800	5,50	50
BCL20H	7314150504848	24,40	54
BCL226	7314150561087	201,30	49
BCL22604	7314150563241	15,45	49
BCL22605	7314150563227	15,45	49
BCL226B	7314150563203	24,75	50
BCL226C	7314150563180	31,00	50
BCL23	7314150498291	514,75	52
BCL2304	7314150505043	38,20	52
BCL2305	7314150505067	26,90	52
BCL2313	7314150505227	17,85	53
BCL2317	7314150505302	1,70	53
BCL2318	7314150505326	59,45	53
BCL235	7314150558735	302,50	50
BCL23503	7314150564200	10,45	49
BCL23504	7314150563265	31,00	50
BCL23505	7314150563289	16,50	50
BCL24	7314150498307	750,00	53
BCL240	7314150558759	464,50	51
BCL24004	7314150563302	34,00	51
BCL24005	7314150563326	19,45	51
BCL24013	7314150564132	10,45	51
BCL2404	7314150505432	42,20	53
BCL2405	7314150505456	29,75	53
BCL2413	7314150505616	17,85	53
BCL2417	7314150505630	1,70	54
BCL25BP	7314150504824	5,50	51
BCL25TP	7314150497508	202,30	51
BCL25TP02	7314150505678	12,50	51
BCL25TP07	7314150505777	10,50	51
BCL2B1	7314150498314	385,00	53
BCL2B2	7314150498321	562,00	54
BCL2BE	7314150504763	10,50	53
BCL2C1	7314150505258	70,75	53
BCL2LHOL	7314150504749	7,65	54
BCL2LHGRE	7314150506064	14,10	54
BCL51	7314150518074	477,50	54
BCL5101	7314150518272	67,95	54
BCL5102	7314150518302	21,60	54
BCL5115	7314150518562	108,10	54
BCL52CNV	7314150518098	160,65	55
BCL52FP	7314150518111	758,65	54
BCL52TP	7314150518135	819,35	55
BCL5B1	7314150518968	617,55	55
BCL5B101	7314150518982	92,65	55
BCL5B1PACK	7314150518159	926,35	55
BCL5C1	7314150519095	64,85	55
BCL5H	7314150519118	172,95	55



BCLAB	7314150504787	8,40	53
FCP-1.8-810	7311518123970	84,34	45
FCP-2.3-860	7311518123994	93,82	45
FFSS-1.5-900FG	7311518275884	70,03	45
FGS-1.0-600	7311518123796	47,78	45
FGS-1.25-700	7311518123802	50,36	45
FGS-1.25-700-WB	7314150398720	53,23	45
FGS-1.6-810	7311518123819	56,74	45
FGS-1.8-810	7311518123826	61,74	45
FP-3M	7311518168612	101,92	36
FS-5	7311518266455	16,80	40
FS-7.5	7311518266479	28,21	41
FS-8	7311518266462	22,87	41
GS-180-F	7311518275488	29,48	40
GS-76	7311518010782	21,61	40
HFGPS-0.7-400FG	7311518275877	46,85	45
HGPS-0.6-360	7311518123680	23,97	45
HGPS-0.6-380	7311518123697	29,30	45
HGPS-0.8-380-WB	7314150398812	33,94	45
HGPS-1.0-400	7311518123703	32,78	45
HGPS-1.0-400-WB	7314150398713	35,79	45
HUS-0.6-380	7311518123659	34,54	45
HUS-0.8-500	7311518123666	38,62	45
HUS-1.0-650	7311518123673	43,47	45
K-AP-1	7311518030117	31,44	40
K-GP-1	7311518030131	34,46	40
LAP-KNIFE	7311518216443	42,75	43
LS-6160-23	7311518041304	9,21	44
LS-COIN 19 CM	7311518031077	30,19	47
LS-COIN 26 CM	7311518030401	32,43	47
LS-COMBINESS	7311518041366	13,33	44
LS-MASSE-4	7311518012014	47,94	46
LS-MASSE-4FG	7311518275891	59,18	46
LS-MASSE-TR-4FG	7311518281106	65,08	46
LS-MERLIN-2.5	7311518012069	50,79	46
LS-MERLIN-2.5FG	7311518281113	65,56	46
LS-PIERRE CORINDON	7311518009977	15,89	44
LS-PIERRE-FAUX	7311518009038	16,88	44
LUB-2015	7311518335427	20,56	44
MCP-2.5-810	7311518124052	75,60	46
MES-3.0-900	7311518123864	55,39	46
MES-3.5-900	7311518123871	61,78	46
MES-3.5-900FG	7311518281120	79,39	46
P108-20-F	7311518275518	32,77	31
P108-23-F	7311518275525	37,46	31
P11	7311518009076	39,35	40
P110-20-F	7311518275532	31,60	31
P110-23-F	7311518275549	35,82	31
P114-SL-40	7311518301149	78,56	34
P114-SL-50	7311518301156	80,19	34
P114-SL-60	7311518301163	87,32	34
P116-SL-40	7311518301101	90,60	34
P116-SL-50	7311518301118	94,87	34
P116-SL-60	7311518301125	97,83	34
P116-SL-70	7311518301132	100,84	34
P1-20	7311518044572	43,63	31
P121-18-F	7311518275662	24,00	32
P121-20-F	7311518275631	25,16	32
P121-23-F	7311518275648	26,34	32
P1-23	7311518332501	49,09	31
P123-19-BULK30	73115183018218	11,79	33
P126-19-F	7311518275297	18,03	32
P126-22-F	7311518275303	23,18	32
P127-19-BULK30	7311518199333	11,60	33
P128-19	7311518160814	15,12	34
P128-19-BULK30	7311518172329	11,91	34
P129-19-BULK30	7311518172336	12,93	34
P130-F	7311518333980	37,16	35
P138-22-F	7311518301279	44,26	31
P140-F	7311518275372	47,14	35
P160-SL-60	7311518301170	105,52	34
P160-SL-75	7311518301187	111,89	34
P160-SL-90	7311518301194	119,74	34
P16-40	7311518013479	78,37	34



P241	7311518008956	13,06	47
P262	7311518299286	16,81	47
P267	7311518299309	17,42	47
P268	7311518299316	17,42	47
P269	7311518299323	13,68	47
P272	7311518299354	21,50	47
P274	7311518299347	20,89	47
P278	7311518299385	21,79	47
P280-SL-60	7311518346508	69,94	35
P280-SL-80	7311518301330	76,09	35
P3-20-F	7311518275259	62,68	31
P3-23-F	7311518275266	65,14	31
P34-27A-F	7311518275464	37,46	37
P34-37	7311518002787	70,23	37
P51-F	7311518275426	53,26	38
P51H-SL	7311518301224	56,19	39
P51-SL	7311518301217	53,26	38
P5-23-F	7311518275280	73,28	31
P52-SL-20	7311518347307	91,26	39
P54H-SL-25	7311518301255	110,01	39
P54-SL-25	7311518301231	110,02	39
P57-25-F	7311518301293	40,96	39
P59-25-F	7311518275655	34,17	39
P64-20-BULK12	7311518288204	40,87	31
P74	7311518124076	63,48	40
P75	7311518124083	62,35	40
PAGS-2.0	7311518327835	32,13	46
PAGS-2.0-900FG	7311518292355	77,22	46
PG-01-F	7311518329334	32,63	32
PG-03-L	7311518242855	33,66	32
PG-12-BULK15	7311518334628	14,39	32
PG-12-F	7311518328122	15,51	32
PG-18-45-F	7311518299033	40,96	35
PG-18-60-F	7311518288853	44,49	35
PG-19-F	7311518295936	60,49	35
PG-56-F	7311518288938	42,14	39
PG-57-F	7311518295943	44,49	39
PG-72	7311518242534	18,33	42
PROF-H	7311518158439	25,58	45
PROF-LOPP	7311518288549	34,59	45
PROF-SEC	7311518288532	21,65	45
PX-L2	7311518233853	58,20	30
PX-L3	7311518233860	58,20	30
PX-M1	7311518233815	58,20	30
PX-M2	7311518233822	58,20	30
PX-M2-L	7311518240714	58,20	30
PX-M3	7311518233839	58,20	30
PXR-L2	7311518233914	84,26	30
PXR-M1	7311518233877	84,26	30
PXR-M2	7311518233884	84,26	30
PXR-M2-L	7311518240738	84,26	30
PXR-M3	7311518233891	84,26	30
PXR-S1	7311518240677	84,26	30
PXR-S2	7311518240684	84,26	30
PXR-S2-L	7311518346799	84,26	30
PX-S1	7311518233785	58,20	30
PX-S2	7311518233792	58,20	30
R1068	7311518044398	6,49	33
R1069P	7311518219574	5,46	33
R1071	7311518222918	10,96	34
R1075-BULK50	7311518220495	1,10	34
R1080P	7311518282479	6,41	33
R112PG	7311518010058	17,46	32
R113PG	7311518044374	18,84	33
R114PG	7311518010065	17,65	32
R114V	7311518042660	33,95	35
R114V-BULK28	7311518177539	23,53	35
R115V	7311518243210	33,86	35
R115V-BULK14	7311518288341	27,53	35
R116V	7311518010164	30,62	35
R116V-BULK36	7311518159924	26,32	35
R119V	7311518029487	52,89	35
R122PG	7311518010072	18,54	32
R123PG	7311518044381	18,65	33
R124PG	7311518010089	18,84	32
R1269P-BULK50	7311518240820	1,41	30
R133PG	7311518328252	13,21	37
R137E	7311518011574	21,34	37
R142P	7311518010126	7,94	32
R143PV	7311518010133	7,25	36



R143PVCB	7311518255633	7,90	36
R144PV	7311518291075	7,31	36
R146VC	7311518046545	8,47	40
R146VS	7311518046538	7,33	36
R146VS-BULK50	7311518159955	4,75	36
R147V	7311518044909	7,32	40
R1601	7311518044640	8,55	33
R160A	7311518201821	26,06	35
R160A-BULK28	7311518337216	20,48	35
R166V	7311518328085	9,80	36
R16V	7311518254513	34,04	35
R16V-BULK14	7311518288334	23,61	35
R201P-BULK80	7311518225209	12,82	32
R202P	7311518219550	22,20	32
R211P	7311518234027	20,66	30
R211P-BULK80	7311518252212	19,23	30
R214SL	7311518301392	26,57	35
R214V	7311518042745	28,77	35
R214V-BULK28	7311518177553	15,48	35
R215V	7311518243227	28,58	35
R216SL	7311518301408	27,87	35
R221P	7311518229412	7,69	32
R221P-BULK50	7311518240653	5,84	32
R223P	7311518237554	21,02	32
R223P-BULK80	7311518240646	17,51	32
R230P	7311518241503	24,70	37
R239P	7311518219567	8,76	32
R260A	7311518201814	25,68	35
R272H	7311518258016	10,28	36
R300P	7311518234034	20,29	30
R303P	7311518234157	21,66	30
R312V	7311518235420	15,02	36
R315V	7311518243234	13,05	36
R318V	7311518029500	13,99	36
R328V	7311518296056	6,87	36
R337E	7311518011598	10,69	38
R341P	7311518011529	5,20	33
R372H	7311518235406	20,25	35
R373A	7311518334710	33,74	35
R376H	7311518335519	14,14	35
R403P	7311518234164	21,89	30
R415V	7311518243241	10,22	36
R4230	7311518341510	7,36	37
R427AE	7311518176068	9,61	37
R437E	7311518011611	10,69	38
R438P	7311518229429	6,50	33
R438P-BULK50	7311518240660	2,00	33
R439P	7311518338244	4,45	33
R440V	7311518254544	7,88	35
R444V	7311518243340	6,12	39
R463P	7311518223908	7,60	33
R474P	7311518011536	5,03	33
R478P	7311518275600	9,27	33
R480P	7311518282486	7,50	33
R500P	7311518234041	20,37	30
R503P	7311518234171	19,86	30
R515VS	7311518046514	5,45	39
R516V	7311518200824	4,58	39
R519V	7311518029517	10,41	36
R600P	7311518240783	20,20	30
R603P	7311518240790	19,33	30
R615V	7311518010119	9,66	36
R619V	7311518029494	32,67	35
R660V	7311518210281	9,04	36
R680V	7311518042752	24,94	35
R716VVCB	7311518255497	28,63	35
R772V	7311518301385	6,71	36
R773V	7311518324414	6,30	36
R811P	7311518234058	26,78	30
R812P	7311518234065	25,33	30
R813P	7311518234072	25,34	30
R815P	7311518240752	26,43	30
R900P	7311518234188	8,24	30
R901P	7311518234195	7,39	30
R902P	7311518234201	6,64	30
R903P	7311518234218	5,42	30
R904P	7311518234225	7,58	31
R905P	7311518234232	6,05	31
R905P-BULK50	7311518252250	2,39	31
R906P	7311518234249	6,05	31



R906P-BULK50	7311518252267	2,53	31
R907P	7311518234256	6,28	31
RAUNI	7311518339289	18,49	37
RBCP230	7311518341558	10,90	37
RCAM30	7311518346959	4,47	36
RCAM36	7311518346973	4,47	36
RD1M	7311518341534	13,57	37
RD7M	7311518341541	25,32	37
RPL230G	7311518341527	25,98	37
RT821P	7311518242237	51,42	30
RT822P	7311518234102	49,33	30
RT823P	7311518234119	56,75	30
RT824P	7311518240776	67,29	30
SE-15-24	7311518029838	8,63	41
SE-15-30	7311518029821	9,17	41
SE-15-30-23	7311518029845	9,25	41
SE-15-32	7311518249168	10,11	41
SE-15-36	7311518141202	10,76	41
SE-15-36-23	7311518258276	10,71	41
SE-16-21	7311518029807	8,79	41
SE-16-21-23	7311518273934	7,59	41
SHARP-X	7311518246895	23,95	44
SHARP-X-DISP	7311518264901	718,21	44
SH-FCP-860	7311518324421	34,64	46
SH-FCS-810	7311518140540	27,87	46
SH-FCS-860	7311518140557	32,00	46
SH-FGS-1.8-810	7311518327828	20,83	46
SH-FGS-600	7311518140649	22,08	46
SH-FGS-700	7311518140656	24,10	46
SH-FGS-800	7311518140663	28,71	46
SH-HFGPS-400FG	7311518282301	19,91	46
SH-HGPS-360	7311518140618	14,92	46
SH-HGPS-380	7311518140625	16,01	46
SH-HGPS-400	7311518207618	17,66	46
SH-HUS-380	7311518140502	16,01	46
SH-HUS-500	7311518140519	21,00	46
SH-HUS-650	7311518140526	23,74	46
SH-MCS-800	7311518140595	28,71	46
SH-MES-900	7311518140601	27,62	46
SH-MES-900FG	7311518282318	41,35	46
SH-MES-F-900	7311518141554	21,52	46
SH-PAGS-900	7311518247866	21,19	46
SH-PAGS-900FG	7311518326944	49,02	46
SH-SUS-800	7311518140809	28,71	46
SUS-2.0-800	7311518123451	86,02	46
W-S-1.5	7311518140816	20,73	47
W-S-2.0	7311518140823	26,42	47
W-S-2.5	7311518140830	32,78	47
W-T-2.0	7311518140847	59,68	47

• Los productos incluidos en los capítulos "Tijeras de poda eléctricas, motosierras, vareadores y accesorios" están sujetos a condiciones comerciales especiales.
 • Precios según tarifa vigente. IVA no incluido.



BAHCO®

FABRICAMOS HERRAMIENTAS PROFESIONALES DESDE 1886



DISTRIBUIDOR



PODA-2025

Follow the fish! www.bahco.com

